

Keysight Radar Measurements

Application Note



Introduction

Today, different types of radar systems are used in a variety of applications: avionic, military, automotive, law enforcement, astronomy, mapping, weather, and more. Within this broad range of uses, several radar technologies have emerged to meet specific needs in terms of performance, cost, size and capability. For example, many police radars use continuous-wave (CW) radar to simply assess Doppler shifts from moving cars; range information is not needed. As a result, low cost and small size are more important than advanced capabilities and features.

At the other extreme, complex phased-array radars may have thousands of transmit/receive (T/R) modules operating in tandem. In addition, these may rely on a variety of sophisticated techniques to improve performance: sidelobe nulling, staggered pulse repetition interval (PRI), frequency agility, real-time waveform optimization, wideband chirps and target-recognition capability are a few examples.

To provide a foundation the discussion presented here, this application note starts with a brief review of radar basics. After that, the remainder of the note focuses on the fundamentals of measuring basic pulsed radars, which is the basis of most radar systems. Where appropriate, this note will discuss adaptations of certain measurements for more complex or modulated pulsed-radar systems. This note will emphasize the measurement of radar signals for transmitter testing. A separate Keysight application note titled Radar, EW & ELINT Testing: Identifying Common Test Challenges (publication 5990-7036EN) discusses signal generation and the characterization of radar receivers and electronic countermeasure (ECM) systems.

Table of contents

1.0 Current trends and technologies in radar	4
Current trends and technologies in radar.....	4
2.0 Radar basics and the radar range equation	5
The fundamentals of radar operation.....	5
Pulse characteristics.....	5
Pulse compression.....	6
Doppler frequency.....	7
The radar range equation.....	8
3.0 Radar block diagram and the radar range equation	14
Relating the range equation to the elements of the radar design.....	15
4.0 Radar measurements	16
Power, spectrum and related measurements	16
Maximum instrument input level.....	17
Measuring pulse power with a power meter.....	18
Pulse frequency and timing measurements with a counter.....	25
Measuring pulse power and spectrum with a signal analyzer.....	28
Measuring with a vector signal analyzer.....	40
Component and subassembly test	53
Direct measurement of power loss with a power meter.....	53
Measuring with a network analyzer.....	54
Antenna measurements	59
Far-field versus near-field antenna test.....	60
Far-field test configuration.....	61
Near-field test configuration.....	63
Example antenna measurement results.....	65
Solution for multi-aperture and phased-array antennas.....	66
Radar cross section	68
Noise figure	70
Y-factor measurement technique.....	71
Direct-noise or cold-source measurement technique.....	72
Selecting the best noise-figure measurement solution.....	72
Time sidelobe level	74
Understanding time sidelobes.....	74
Applying the time sidelobe method.....	74
Weighting the output signal.....	76
Making time sidelobe measurements.....	76
Applying the results.....	77
Phase noise, AM noise, and spurs	78
Making a direct spectrum measurement of phase noise with a spectrum analyzer.....	80
Measuring phase noise using phase detector.....	81
Measuring phase noise using a signal-source analyzer.....	82
Measuring phase noise with a dedicated test system.....	84
5.0 Summary	85
Related information	86
References	87

1.0 Current trends and technologies in radar

Current trends and technologies in radar

For engineers and scientists, the names behind the earliest experiments in electromagnetism are part of our everyday conversations: Heinrich Hertz, James Clerk Maxwell and Nikola Tesla. Fast forward from their work in the late 19th and early 20th centuries to the early 21st Century: the fundamental concept—metallic objects reflect radio waves—has evolved into a host of technologies that are pushed to the extremes in military applications: detecting, ranging, tracking, evading, jamming, and more.

As is the case in commercial electronics and communications, the evolution from purely analog designs to hybrid analog/digital designs continues to drive advances in radar system capability and performance. Frequencies keep reaching higher and signals are becoming increasingly agile. Signal formats and modulation schemes—pulsed and otherwise—continue to become more complex, and this demands wider bandwidth. Advanced digital signal processing (DSP) techniques are being used to disguise system operation and thereby avoid jamming. Architectures such as active electronically steered array (AESA) rely on advanced materials such as gallium nitride (GaN) to implement phased-array antennas that provide greater performance in beamforming and beamsteering.

Within the operating environment, the range of complexities may include ground clutter, sea clutter, jamming, interference, wireless communication signals, and other forms of electromagnetic noise. It may also include multiple targets, many of which utilize materials and technologies that present a reduced radar cross section.

This updated edition of our Radar Measurements application note reflects these realities. Because any document begins to lag behind current reality at the moment of publication, the content included here is a mix of timeless fundamentals—the radar range equation—and emerging ideas such as the time sidelobe level measurement technique. Many of the sidebars highlight products—hardware and software—that include future-ready capabilities that can evolve along with the continuing evolution of radar systems.

Whether you choose to read this note from cover to cover or selectively sample the sections, we hope you find material—timeless or timely—that will be useful in your day-to-day work, be it on new designs or system upgrades.

2.0 Radar basics and the radar range equation

The fundamentals of radar operation

The essence of radar is the ability to gather information about a target – location, speed, direction, shape, identity or simply presence. This is done by processing reflected radio frequency (RF) or microwave signals in the case of primary radars, or from a transmitted response in the case of secondary radars.

In most implementations, a pulsed-RF or pulsed-microwave signal is generated by the radar system, beamed toward the target in question and collected by the same antenna that transmitted the signal. This basic process is described by the radar range equation found on page 6. The signal power at the radar receiver is directly proportional to the transmitted power, the antenna gain (or aperture size), and the radar cross section (RCS) (i.e., the degree to which a target reflects the radar signal). Perhaps more significantly, it is indirectly proportional to the fourth power of the distance to the target. Given the large attenuation that occurs while the signal is traveling to and from the target, having high power is very desirable; however, it is also difficult due to practical problems such as heat, voltage breakdown, dynamic power requirements, system size and, of course, cost.

Pulse characteristics

The characteristics of a pulsed radar signal largely determine the performance and capability of the radar. Pulse power, repetition rate, width and modulation are traded off to obtain the optimum combination for a given application. Pulse power directly affects the maximum distance, or range, of a target that can be detected by the radar.

Pulse repetition frequency (PRF) determines the maximum unambiguous range to the target. The next (non-coded) pulse cannot be sent until the previous pulse has traveled to the target and back. (Coded pulses can be sent more frequently because coding can be used to associate responses with their corresponding transmitted pulse.)

Pulse width determines the spatial resolution of the radar: pulses must be shorter than the time it takes for the signal to travel between the target details; otherwise, the pulses overlap in the receiver.

The pulse width and the shape of the pulse also determine the spectrum of the radar signal. Decreasing the pulse width increases signal bandwidth. A wider system bandwidth results in higher receiver noise for a given amount of power, which reduces sensitivity. Also, the pulse spectrum may exceed regulated frequency allotments if the pulse is too short.

The shape can be the familiar trapezoidal pulse with rapid but controlled rise and fall times, or any of a number of alternative shapes such as Gaussian and raised-cosine. Because the pulse shape can determine the signal bandwidth and also affect the detection and identification of targets, it is chosen to suit the application.

Short pulses with a low repetition rate maximize resolution and unambiguous range and high pulse power maximizes the radar's range in distance. However, there are practical limitations in generating short, high-power pulses. For example, higher peak power will shorten the life of tubes used in high-power amplifier design. This conundrum would be the barrier to increasing radar performance if radar technology stopped here. However, complex waveforms and pulse-compression techniques can be used to greatly mitigate the power limitation on pulse width.

Pulse compression

Pulse compression techniques allow relatively long RF pulses to be used without sacrificing range resolution. The key to pulse compression is energy. Using a longer pulse, one can reduce the peak power of the transmitted pulse while maintaining the same pulse energy. Upon reception, the pulse is compressed with a match-correlation filter into a shorter pulse, which increases the peak power of the pulse and reduces the pulse width. Pulse-compressed radar thereby realizes many of the benefits of a short pulse: improved resolution and accuracy; reduced clutter; better target classification; and greater tolerance to some electronic warfare (EW) and jamming techniques. One area that does not realize an improvement is minimum range performance. Here the long transmitter pulse may obscure targets that are close to the radar.

The ability to compress the pulse with a match filter is achieved by modulating the RF pulse in a manner that facilitates the compression process. The matching filter function can be achieved digitally using the cross-correlation function to compare the received pulse with the transmitted pulse. The sampled receive signal is repeatedly time shifted, Fourier transformed and multiplied by the conjugate of the Fourier transform of the sampled transmit signal (or a replica). The output of the cross-correlation function is proportional to the time-shifted match of the two signals. A spike in the cross-correlation function or matching-filter output occurs when the two signals are aligned. This spike is the radar return signal, and it typically may be 1000 times shorter in time duration than the transmitted pulse. Even if two or more of the long transmitted pulses overlap in the receiver, the sharp rise in output only occurs when each of the pulses are aligned with the transmit pulse. This restores the separation between the received pulses and, with it, the range resolution. Note that the receive waveform is windowed using a Hamming or similar window to reduce the time-domain sidelobes created during the cross-correlation process.

Ideally, the correlation between the received and transmitted signals would be high only when the transmit and receive signals are exactly aligned. Many modulation techniques can be used to achieve this goal: linear FM sweep, binary phase coding (e.g., Barker codes), or polyphase codes (e.g., Costas codes). Graphs called ambiguity diagrams illustrate how different pulse compression schemes perform as a function of pulse width and Doppler frequency shift, as shown in Figure 1. Doppler shift can reduce detector sensitivity and cause errors in time alignment.

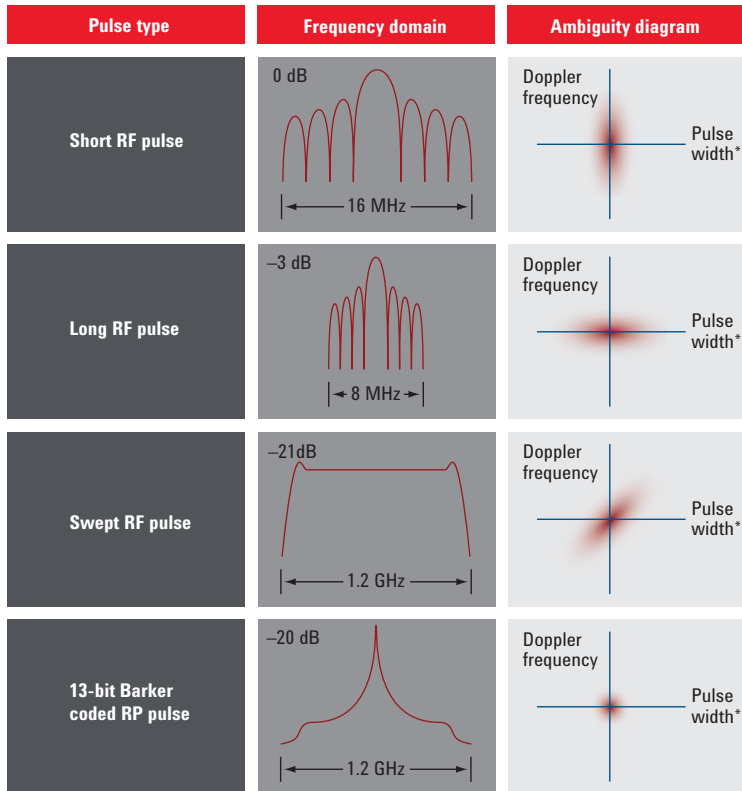

Figure 1. An ambiguity diagram illustrates location accuracy versus Doppler accuracy. This figure shows relative ambiguity diagrams for different types of radar pulses.

* The term pulse width on the ambiguity diagram refers to the pulse width at the radar detector output.

Although Doppler frequency shift can cause errors, it also gives radar operators important information about the target.

Doppler frequency

Most targets of interest are moving—and these cause the frequency of the returned signal to be shifted higher if the target is moving toward the radar and lower if the target is moving away. This is the familiar Doppler frequency shift often associated with passing sirens and train whistles. As many people who have received speeding tickets can attest, police radars using Doppler frequency shift can determine their car's (target's) radial velocity. In many radar systems, both the location and radial velocity are useful information.

Doppler frequency shift can reduce the sensitivity of location detection. Recall that the output of the cross-correlation filter used for detection is proportional to the match between the received and transmitted signals. If the received signal is slightly lower or slightly higher in frequency, then the output of the cross-correlation filter is somewhat lower. For a simple pulse, the response of the cross correlation filter follows the familiar $\sin(x)/x$ shape as a function of Doppler frequency. In extreme cases, the frequency shift of the received signal may shift far enough to correlate with a sidelobe of the transmit signal. Note that short pulses have a relatively wide initial lobe in the $\sin(x)/x$ response and so tend to be Doppler tolerant compared to longer pulses. Figure 1 compares the ambiguity diagrams for short and long pulses. In other pulse compression schemes, such as Barker coding, the matching-filter output drops off much faster than the $\sin(x)/x$ of the simple pulse, which makes them Doppler intolerant. Doppler shift in linear FM pulses can create an error in the location information because the highest cross correlation occurs where the swept frequencies in the receive pulse are best aligned with the swept frequencies in the transmit pulse. This offset is directly proportional to the Doppler shift.

The radar range equation

The radar range equation describes the important performance variables of a radar and provides a basis for understanding the measurements that are made to ensure optimal performance. This section will describe the basic derivation of the range equation and examine the important performance variables identified by the equation. The remainder of this application note will then discuss the measurement methods and options that are available to evaluate these performance variables.

The derivation starts by analyzing a simple spherical scattering model of propagation for an isotropic radiator, or point-source antenna. Assume, for simplicity, that the antenna equally illuminated the interior of an imaginary sphere with equal power density in each unit of surface area, where the surface area of the sphere is:

$$A_s = 4(\pi)R^2$$

Where:

A_s = area of a sphere

R = radius of the sphere

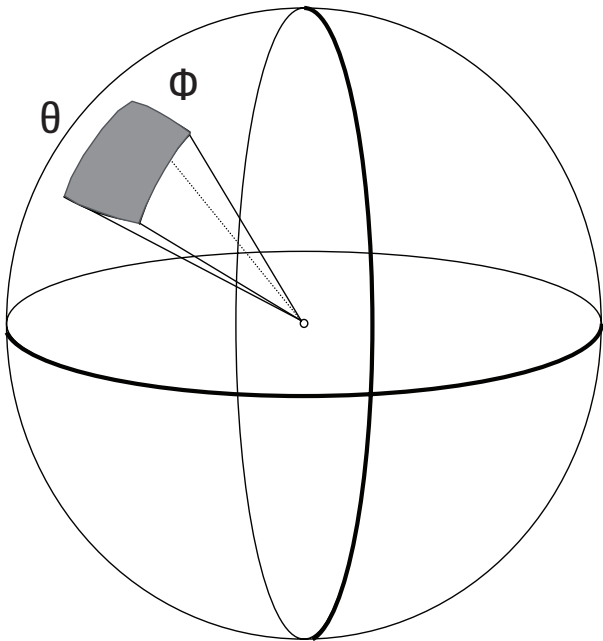

Figure 2. Ideal isotropic antenna radiation

The power density is found by dividing the total transmit power, in watts, by the surface area of the sphere in square meters.

$$\rho = \frac{P_t}{A_s} = \frac{P_t}{4\pi R^2}$$

Where:

ρ = power density in watts per square meters

P_t = total transmitted power in watts

Because radar systems use directive antennas to focus radiated energy onto a target, the equation can be modified to account for the directive gain G of the antenna. The gain of the antenna is defined as the ratio of power directed toward the target compared to the power from an ideal isotropic antenna.

$$\rho_T = \frac{P_t G_t}{4\pi R^2}$$

Where:

ρ_T = power density directed toward the target from directive antenna

G_t = gain of the directive antenna

This equation describes the transmitted power density that strikes the target. Some of that energy will be reflected off in various directions and some of the energy will be reradiated back to the radar system. The amount of this incident power density that is reradiated back to the radar is a function of the radar cross section (RCS or σ) of the target. RCS (σ) has units of area and is a measure of target size, as seen by the radar. With this information the equation can be expanded to solve for the power density returned to the radar antenna. This is done by multiplying the transmitted power density by the ratio of the RCS and area of the sphere.

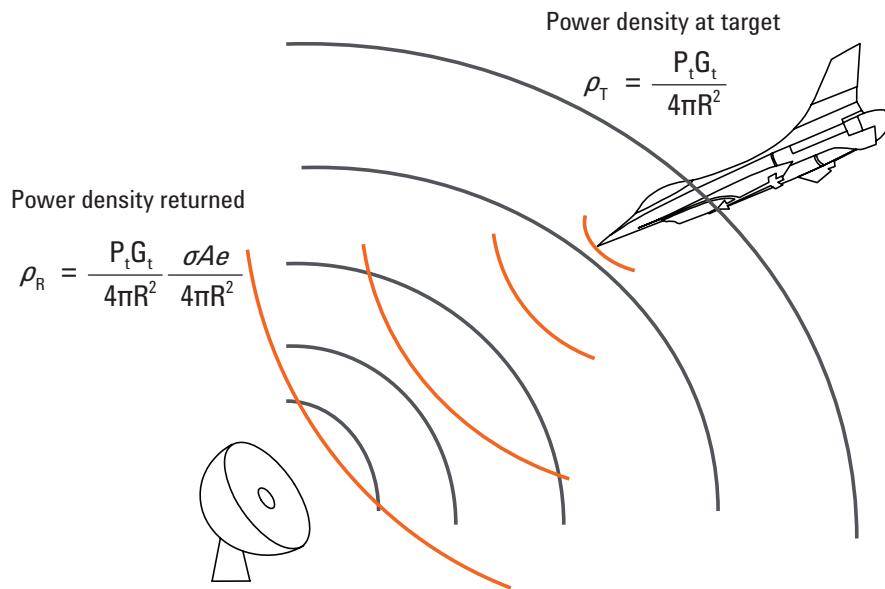

Figure 3. Transmitted and reflected power returned to the radar

$$\rho_R = \frac{P_t G_t}{4\pi R^2} \frac{\sigma}{4\pi R^2}$$

Where:

ρ_R = power density returned to the radar, in watts per square meter

σ = RCS in square meters

A portion of this signal reflected by the target will be intercepted by the radar antenna. This signal power will be equal to the return power density at the antenna multiplied by the effective area, A_e of the antenna.

$$S = \frac{P_T G_T \sigma A_e}{(4\pi)R^4}$$

Where:

- S = signal power received at the receiver in watts
- P_T = transmitted power in watts
- G_T = gain of transmit antenna (ratio)
- σ = RCS in square meters
- R = radius or distance to the target in meters
- A_e = effective area of the receive antenna square meters

Antenna theory allows us to relate the gain of an antenna to its effective area as:

$$A_e = \frac{G_R \lambda^2}{4\pi}$$

Where:

- G_R = gain of the receive antenna
- λ = wavelength of radar signal in meters

The equation for the received signal power can now be simplified. Note that for a monostatic radar the antenna gain G_T and G_R are equivalent. This is assumed to be the case for this derivation.

$$S = \frac{P_T G_T G_R \lambda^2 \sigma}{(4\pi)^2 R^4 4\pi} \rightarrow S = \frac{P_T G^2 \lambda^2 \sigma}{(4\pi)^3 R^4}$$

Where:

- S = signal power received at the receiver in watts
- P_T = transmitted power in watts
- G = antenna gain (assume same antenna for transmit and receive)
- λ = wavelength of radar signal in meters
- σ = RCS of target in square meters
- R = radius or distance to the target in meters

Now that the signal power at the receiver is known, the next step is to analyze how the receiver will process the signal and extract information. The primary factor limiting the receiver is noise and the resulting signal-to-noise (S/N) ratio.

The noise power (theoretical limit) at the input of the receiver is described as Johnson noise or thermal noise. It is a result of the random motion of electrons, and is proportional to temperature.

$$N = kTB_n$$

Where:

N = noise power in watts

k = Boltzmann's constant (1.38×10^{-23} Joules/degree Kelvin)

T = temperature in degrees Kelvin

B_n = system noise bandwidth

At a room temperature of 290° K the available noise power at the input of the receiver would then be 4×10^{-21} W/Hz, -203.98 dBW/Hz, or -173.98 dBm/Hz. The available noise power at the output of the receiver will always be higher than predicted by the above equation due to noise generated within the receiver. The output noise will be equal to the ideal noise power multiplied by the noise factor and gain of the receiver.

$$N_o = GF_n kTB$$

Where:

N_o = total receiver noise

G = gain of the receiver

F_n = noise factor

In addition to noise factor, other limiting factors include oscillator noise (such as phase noise or AM noise), spurs, residuals, and images. These signals may or may not be noise-like but will impact the receiver's ability to process the received signals. For simplicity these factors will not be considered specifically in this derivation. However, phase noise and spurs are important radar measurements that can affect radar performance and are therefore included as part of the measurement discussion presented later in this application note.

As noted above, the available noise power at the output of the receiver will always be higher than the thermal Johnson noise. This is because extra noise is generated within the receiver. The total output noise will be equal to the Johnson noise power multiplied by the noise factor F_n and gain G of the receiver.

The gain of the receiver can be rewritten as the ratio of the signal output of the receiver to the signal input, ($G = S_o/S_i$). Solving for the noise factor F_n the equation then becomes:

$$F_n = \frac{S_i / N_i}{S_o / N_o} \quad \text{Where } N_i = kTB$$

By definition, the noise factor is the ratio of the S/N in to the S/N out.

The equation can be rewritten in a different form:

$$F_n = \frac{N_o}{kT_o B_n G} \quad \text{Where } G = \frac{S_o}{S_i}$$

Where:

- F_n = noise factor
- N_o = total receiver noise
- G = gain of the receiver
- S_o = receiver output signal
- S_i = receiver input signal
- T_o = room temperature
- k = Boltzmann's constant
- B_n = receiver noise bandwidth

Because noise factor describes the degradation of signal-to-noise as the signal passes through the system, the minimum detectable signal (MDS) at the input can be determined, which corresponds to a minimum output S/N ratio with an input noise power of kTB .

$S_i \rightarrow S_{\min}$ when minimum S_o/N_o condition is met

$$S_{\min} = kT_o B_n F_n \left(\frac{S_o}{N_o} \right)_{\min}$$

Where:

- S_{\min} = minimum power required at input of the receiver
- F_n = noise factor
- $(S_o/N_o)_{\min}$ = min ratio required by the receiver processor to detect the signal

Now that the minimum signal level required to overcome system noise is defined, the maximum range of the radar can be calculated by equating the MDS (S_{\min}) to the signal level reflected from our target at maximum range (set S_{\min} = to equation for S above).

$$S_{\min} = kT_o B_n F_n \left(\frac{S_o}{N_o} \right)_{\min} = \frac{P_T G^2 \lambda^2 \sigma}{(4\pi)^3 R_{\max}^4}$$

From this equation we can solve for the maximum range of our radar.

$$R_{\max} = \frac{P_T G^2 \lambda^2 \sigma}{kT_o B_n F_n (S/N) (4\pi)^3}$$

Where:

- R_{\max} = maximum distance to detectable target in meters
- P_T = transmitted power in watts
- G = antenna gain (assume same antenna for transmit and receive)
- λ = wavelength of radar signal in meters
- σ = RCS of target in square meters
- k = Boltzmann's constant
- T = room temperature in Kelvin degrees
- B_n = receiver noise bandwidth in hertz
- F_n = noise factor
- S/N = min signal-to-noise ratio required by receiver processor to detect the signal

This equation describes the maximum target range of our radar based on transmitter power, antenna gain, RCS of the target, system noise figure, and minimum signal-to-noise ratio. In reality, this is a simplistic model of system performance. There are many factors that will also affect system performance including modifications to the assumptions made to derive this equation. Two additional items that should be considered are system losses and pulse integration that may be applied during signal processing. Losses in the system will be found both in the transmit path (L_T) and in the receive path (L_R). In a classical pulsed radar application, we could assume that multiple pulses would be received, from a given target, for each position of the radar antenna (because the radar's antenna beamwidth is greater than zero, we can assume that the radar will dwell on each target for some period of time) and therefore could be integrated together to improve the performance of the radar system. Because this integration may not be ideal we will use an integration efficiency term $E_i(n)$, based on the number of pulses integrated, to describe integration improvement.

Including these terms, the radar equation yields:

$$R^4 = \frac{P_T G^2 \lambda^2 \sigma E_i(n)}{kTB_n F_n (S/N) (4\pi)^3 L_T L_R}$$

Where:

L_T = losses in the transmitter path

L_R = losses in the receive path

$E_i(n)$ = integration efficiency factor

The entire equation can be converted to log form (dB) to simplify the discussion:

$$40\text{Log}(R) = P_T + 2G_{\text{dB}} + 20\text{Log}_{10}\lambda + \sigma_{\text{dBsm}} + E_{\text{idB}}(n) + 204\text{dBW/Hz} - 10\text{Log}(B_n) - F_n - (S/N) - L_{T\text{dB}} - L_{R\text{dB}} - 33\text{dB}$$

Where:

R = maximum distance in meters

P_T = transmit power in dBW

G = antenna gain in dB

λ = wavelength of radar signal in meters

σ = RCS of target measured in dBsm, or dB relative to a square meter

F_n = noise figure (Noise figure = noise factor converted to dB)

S/N = min signal-to-noise ratio required by receiver processing functions
detect the signal in dB

The 33 dB term comes from $10 \log(4\pi)^3$ and the 204 dBW/Hz from Johnson noise at room temperature.

The dB term for RCS σ_{dBsm} is determined in dBsm or dB relative to a one meter sphere (sphere with cross section of a square meter), which is the standard target for radar cross section measurements.

For multiple-antenna (i.e., arrayed) radars, the maximum range would grow proportionally to the number of elements, assuming equal performance from each element.

3.0 Radar block diagram and the radar range equation

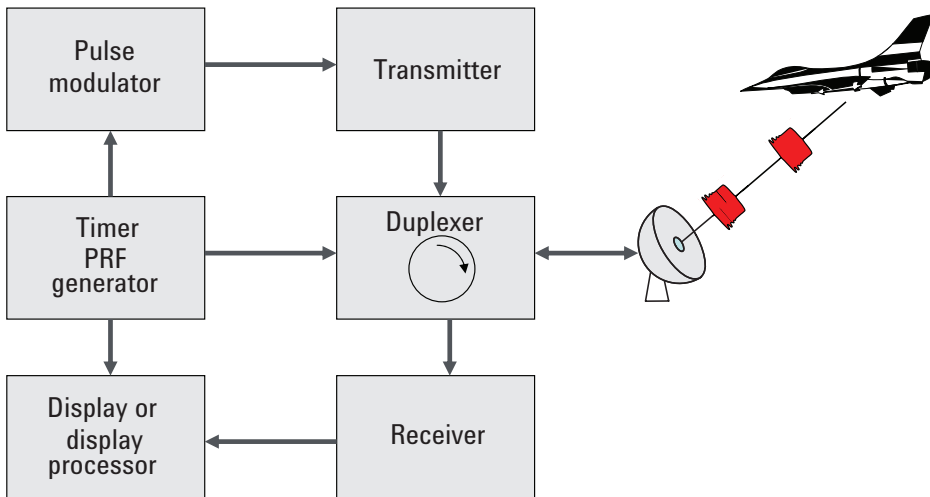

Figure 4. Basic radar block diagram

Figure 4 shows a basic radar block diagram. The diagram could be much more complicated; however, this diagram shows all of the essential blocks of the radar system. The diagram shows the master timer or PRF generator as the central block of the system. The PRF generator will time synchronize all components of the radar system shown in Figure 4 through connections to the pulse modulator, duplexer or transmit/receive switch, and the display processor. In addition, connections to the receiver would provide gating for front-end protection or timed gain control such as sensitivity time control (STC).

For the purpose of this application note we will focus on the transmitter, receiver, duplexer, and antenna sections of this diagram. As these blocks are expanded, the parameters of the range equation will be allocated to each block or component.

Relating the range equation to the elements of the radar design

Figure 5 shows an expanded view of the transmitter and receiver sections of the block diagram. This version shows a hybrid analog/digital design that enables many of the latest techniques. The callouts indicate the location of key variables within the simplified radar equation:

$$40 \text{ Log}(R_{\text{max}}) = P_T + 2G + 20 \text{ Log}\lambda + \sigma + E_i(n) + 204 \text{ dBW/Hz} - 10 \text{ Log}(B_n) - F_n - (S/N) - L_T - L_R - 33 \text{ dB}$$

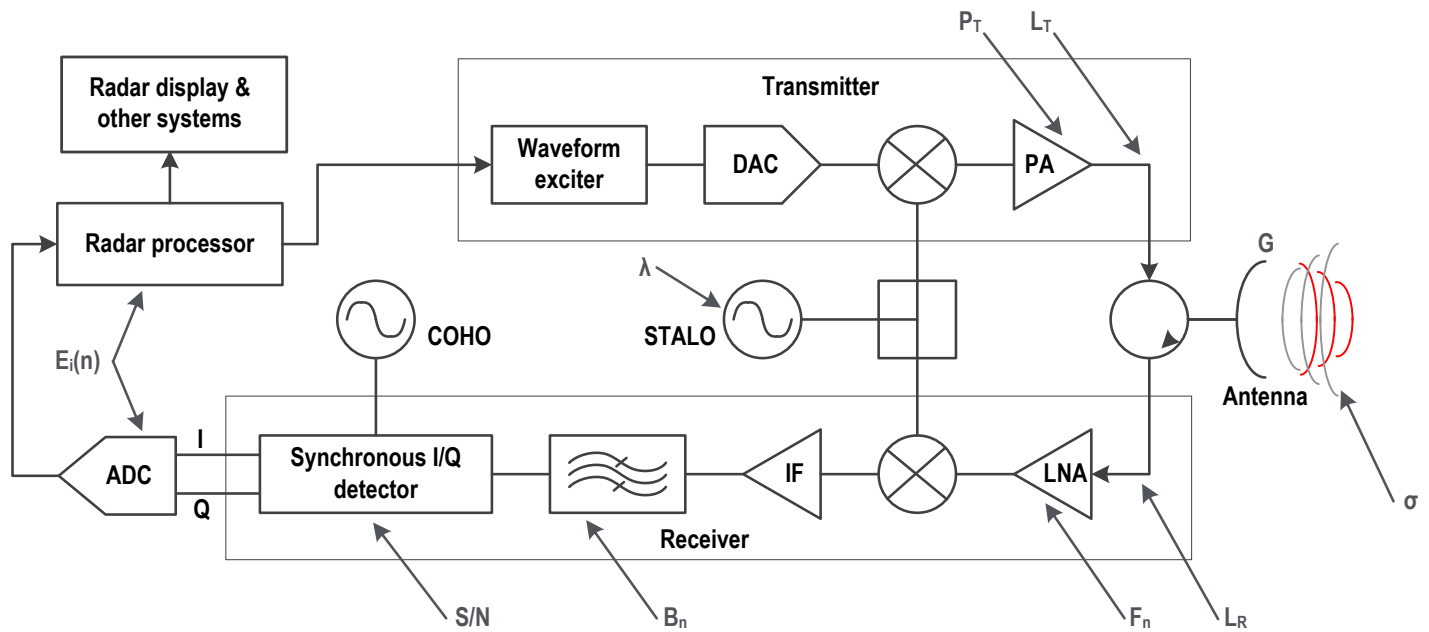

Figure 5. Relating key variables in the radar range equation to hybrid analog/digital implementations of the transmitter and receiver sections of a radar system

4.0 Radar measurements

Power, spectrum and related measurements

Generally, a radar transmitter is the most costly component of the system with the highest power consumption, most stringent cooling requirements, and greatest influence on system performance.

There are many different terms used when talking about power, as shown in Figure 6. Average power is the power that is integrated over the complete time waveform (on time and off time) of the radar. If the pulse width and PRF are not constant, the integration time must be long enough to represent all possible variations in pulse parameters. Most typical RF and microwave power meters are average power meters and respond to the heating energy of the signal. Peak power is the maximum instantaneous power. Pulse power is the integrated or average power for one complete pulse.

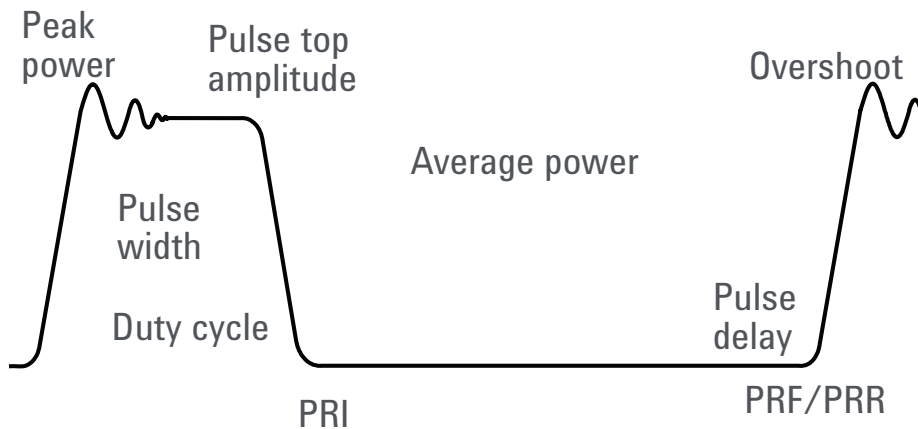

Figure 6. Pulse parameters

Other parameters, including duty cycle, pulse width, PRF, and rise and fall times as shown in Figure 6, are useful for characterizing the power of the radar signal.

From a radar equation standpoint, the power term corresponds to the power of the transmit pulse. If the integration term is excluded, the equation applies to a single pulse. Therefore, it can be useful to examine the peak and pulse power on an individual pulse basis. This technique is becoming more important for modern radar systems in which pulse width and PRF are dynamically adjusted and the pulse profile may be contoured to improve system performance. It is also becoming easier to perform with modern test equipment.

It should be noted that average power measurements are a common method for characterizing the power of a radar signal. These are simple to perform and require only low-cost instruments. If pulse characteristics, such as the duty cycle of the radar signal, are known, the pulse power can be derived or estimated based on average power. Note, however, that this derived result does not provide information about droop, or any peak excursions that may occur due to ringing or overshoot. The result would be nearly equivalent to the pulse-top amplitude, and in the case of a perfectly square pulse, it would be equivalent to the true peak power or pulse power.

Along with measuring power, the spectrum shape is critical to verifying that a radar system is operating efficiently. For example, an unsymmetrical or incorrect spectral shape indicates a radar that is operating less than optimally. In such cases, the radar may be wasting power by transmitting or splattering power at unwanted frequencies, causing out-of-band interference. For some radar systems, pulse shaping is used to reduce the level of the spectral sidelobes, to improve the efficiency and life of radar components, and to reduce bandwidth.

There are several options for measuring radar power, pulse characteristics and spectrum including the use of a power meter, signal/spectrum analyzer, or vector signal analyzer. Because each instrument has advantages and limitations, the best choice is determined by the measurement objectives and the constraints on the radar and the test instrument. This section will describe how to make measurements with each of these instruments.

Maximum instrument input level

One of the first things to consider is the magnitude of RF power that could be encountered. Parameters such as frequency, antenna match (SWR), pulse width (PW), pulse repetition time (PRT), and duty cycle will affect power measurements and selection of measurement hardware.

RF and microwave instruments are limited in both the amount of average power and the amount of peak power that can be input without damaging the instrument. For typical radar systems, with pulse powers of approximately 1 MW, a directional coupler is required to sample the transmitter power and provide a safe drive level to the test instrument.

Measuring pulse power with a power meter

The most common (and lowest-cost) way to measure pulse power is with a power meter. The right power meter can provide a number of measurements including average power, peak power, duty cycle, and even power statistics. One of the first things to consider when measuring with a power meter is the power sensor.

The power sensor

The power sensor converts high-frequency power to a DC or low-frequency signal that the power meter can then measure and relate to a certain RF or microwave power level. The three main types of sensors are thermistors, thermocouples, and diode detectors. There are benefits and limitations associated with each type of sensor. We will briefly cover the theory of each type and describe the advantages and limitations of each.

Thermistor-based sensors

Thermistor-based sensors implement a balanced Wheatstone bridge. When RF power is applied to a thermistor in the bridge, it warms and its resistance decreases. This change in resistance unbalances the bridge and produces a differential input to the amplifier. Being a feedback loop, the amplifier decreases the DC bias to the bridge enough to bring the bridge back into balance. The difference in DC power can then be measured with the power meter and related to the RF power incident on the thermistor.

The downside of these sensors is their sensitivity to temperature changes. To address this problem, a second thermistor may be added to detect and correct for the ambient temperature.

Thermocouple-based sensors

Thermocouple sensors are based two principles: metal generates a voltage due to temperature differences between hot and cold junctions; and that different metals will create different voltages. Thermocouple sensors exploit this behavior by detecting and correlating these voltage changes, which are a result of changes in temperature caused by incident RF power on the thermocouple element. Because the change of voltage is small, many junctions are used connected in series, which is referred to as a thermopile.

Both thermistor- and thermocouple-based sensors can be used to measure average power but can not be used to directly measure peak power.

P-Series power meters

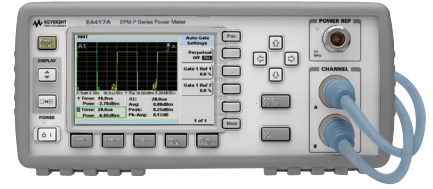

Quickly and accurately characterize the peak power, average power, duty cycle & power statistics of radar signals

- 100 MSa/s continuous sampling
- Automated gating and triggering
- 13 ns rise time for accurate measurements of peak power on pulses as narrow as 50 ns
- Single- and dual-channel models

Diode-based sensors

Unlike thermistors and thermocouples, a diode does not measure the heat content of a signal but instead rectifies the signal. The matching resistor (approximately 50 ohms) is the termination for the RF signal. RF voltage is rectified and converted to DC voltage at the diode. A bypass capacitor is used as a low-pass filter to remove any RF signal getting through the diode. A major attribute of the diode sensor is sensitivity, permitting power measurements as low as -70 dBm (100 pW).

One should consider, however, if these measurements are independent of signal content. If we expand the diode equation into a power series, we find that the rectified output voltage is a function of the square of the input signal voltage up to a power level of about -20 dBm. This performance yields a rectified output that is proportional to the RF signal power regardless of signal content.

As the power level increases above -20 dBm, the rectification process becomes increasingly linear and the output voltage transitions to a function of the input voltage (rather than the square of the input voltage). For complex signals, the output is then dependent upon the phase relationships among the various components of the input signal. In other words, the output is related to the peak power of the signal rather than the heating power of the signal contained within the video bandwidth (VBW) of the sensor. For pulsed signals, this is very important.

Many of today's average power measurements require a dynamic range greater than 50 dB. Keysight's approach to meeting this need is to create an average power sensor with wide dynamic range that incorporates diode stacks in place of single diodes to extend square-law operation to higher power levels (though at the expense of sensitivity). A series connection of m diodes results in a sensitivity degradation of $10 \cdot \log(m)$ dB and an extension upwards in power of the square law region maximum power of $20 \cdot \log(m)$ dB, yielding a net improvement in square law dynamic range of $10 \cdot \log(m)$ dB compared to a single-diode detector. The E-series E9300 power sensors are implemented with a two-diode stack pair for the low-power path (-60 to -10 dBm), a resistive divider attenuator and a five diode stack pair for the high-power path (-10 to $+20$ dBm).

Measuring power with an average power meter

An average power meter can be used to report average power and pulse power if the duty cycle of the signal is known. There are some advantages to using this method but there are also a number of points that must be taken into consideration. When an average power meter reports a pulse or peak power result, it does so by deriving the result from the average power and a known duty cycle. The result is accurate for an ideal or nearly ideal pulse signal but it does not reflect aberrations due to a non-square pulse shape and will not detect peak excursions that may result from ringing or overshoot. The main advantage of average power meters is that they are the lowest-cost solution. Both the power meters and sensors are less expensive than the corresponding peak power meters and sensors. They also generally have the ability to measure over a wider dynamic range, frequency range, and bandwidth, and can measure a signal no matter how fast the rise time or narrow the pulse width.

Figure 7 shows an example of measuring pulse and average power using an average power meter and a known duty cycle. The example uses a simple 10 μs pulse with period of 40 μs . The pulse signal is set with a power level of approx 0 dBm. The average power result is -6.79 dBm. Since the duty cycle is known (10 μs divided by 40 μs , or 25%) it can be entered into the power meter to obtain the result of the pulse power, which is measure at -0.77 dBm. The equation and calculation used to come to this result is shown in Figure 7.

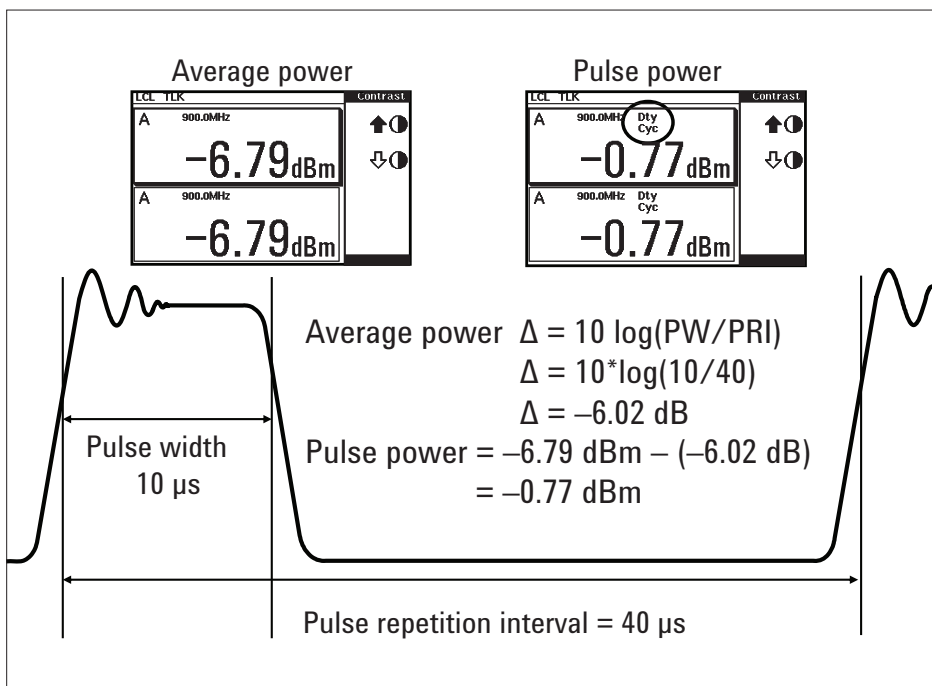

Figure 7. Using an average power meter to derive pulse power.

In reality, as was previously mentioned, the pulse may not be purely rectangular since there is an associated rise and fall time, as well as possible overshoot on the signal. The combination of these effects creates an error in the calculated result.

Measuring power with a peak power meter

The peak power meter with sensor has the advantage in that it is capable of making direct measurements of peak power and pulse power. This is particularly useful for shaped or modulated pulses for which deriving pulse power from average power may be inadequate.

Figure 8 shows an example of measuring peak and pulse power using the Keysight P-Series peak power meter. A convenient feature of the meter is its trace display, which allows you to view the envelope of the pulse signal that is being measured. The meter operates by continuously sampling the signal with a 100 MS/s digitizer, buffering the data, and calculating the result. This gives the meter greater measurement versatility, including flexible triggering, time gating with multiple gates, and the ability to take single-shot measurements.

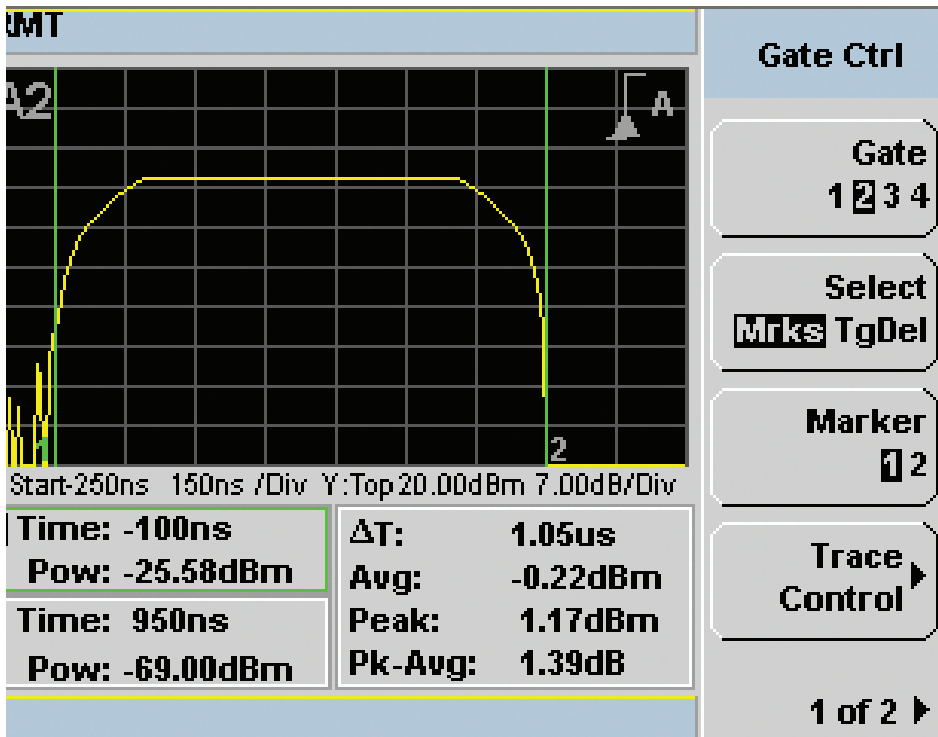

Figure 8. Using the P-Series peak power meter to measure peak power, gated pulse power, and peak-to-average ratio. Due to the shape of this pulse the peak power is 1.39 dB higher than the pulse power.

P-Series power meters and power sensors



Keysight power meters operate with various sensors (CW, average, and peak and average) and cover numerous frequency and power ranges to accurately measure the power of RF and microwave signals. Keysight P-Series wideband power meters (30 MHz video bandwidth) such as the N1911A (single channel) and N1912A (dual channel) provide measurements including peak, peak-to-average ratio, average power, rise time, fall time and pulse width.

When used with an N1921A or N1922A wideband power sensor, an N1911/12A P-Series power meter provides a measurement frequency range of 50 MHz to 40 GHz. Key capabilities of the N1911/12A with the N1922A include the following:

- Internal zeroing and calibration while connected to the unit under test
- Predefined formats for radar, WiMAX™, DME and more
- Average triggering for average power measurements
- Single-shot real-time capture at 100 MSa/s
- High-speed CCDF statistical analysis
- One-screen pulse analysis: auto scale, auto gate, rise/fall time, duty cycle
- Difference and ratio math functions: A-B, B-A, A/B and B/A
- Two-year calibration cycle

In Figure 9, a time gate is set up to measure over just one pulse. The meter can simultaneously report the peak power, average power, and peak-to-average power result within the time gate. In this case, the reported average power result of -0.09 dBm is equal to the pulse power because the time gate is set to specifically measure one pulse. The peak power is slightly higher at 0.24 dBm, a likely result due to some overshoot. The peak-to-average ratio of 0.32 dB is the difference between the two values.

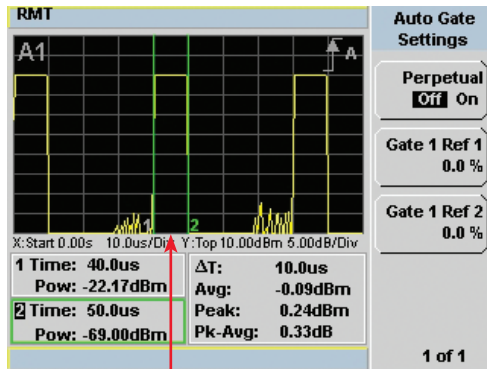

“Perpetual” turns on the auto gating feature, which simplifies pulse measurements by repositioning the gates automatically according to the changes in the pulse width.

U2020 X-Series USB peak and average power sensors



Get fast, easy measurements of peak and average power in a compact and portable form factor

- Internal zeroing and calibration while connected to the unit under test
- Measure peak and average power
- Frequency range of 50 MHz to 40 GHz (sensor dependent)
- Wide peak power dynamic range of -30 to $+20$ dBm
- Speed of up to 3,500 readings per second in buffered mode
- Built-in trigger in/out function eliminates the need for an external module or power supply
- Internal zeroing capability eliminates the need for external calibration

Gate will automatically change according to the pulse width

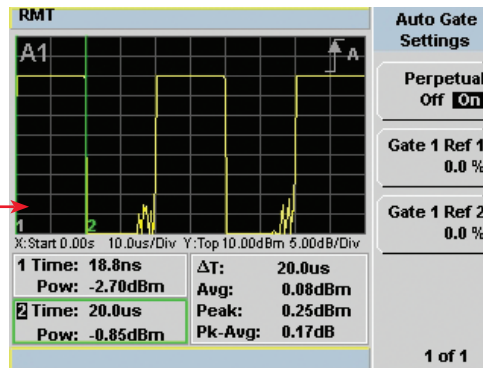

Figure 9. The P-Series power meter has the capability to directly measure pulse power by automatically positioning a gate on a pulse.

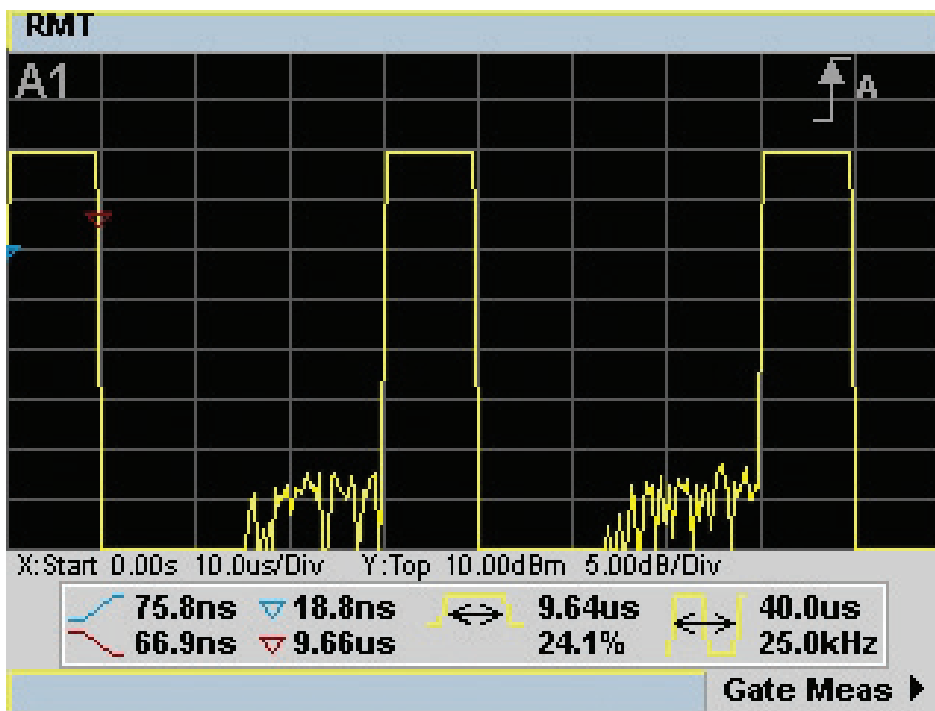

Figure 10. The P-Series peak power meter will automatically measure pulse characteristics including rise time, fall time, pulse width, and pulse period.

The P-Series power meter also has other features that are convenient for measuring radar signals. Figure 10 illustrates its automatic measurements of pulse characteristics such as pulse width, pulse period, rise time, and fall time. The meter's capability to automatically adjust the time gate to the width of the pulse using its "perpetual" setting is shown in Figure 9. This simplifies measurements of pulse power without requiring prior knowledge of the pulse width. This is especially convenient for radars that have dynamic pulse widths and PRI.

Peak power meters do have limitations. One example is frequency coverage: The P-Series peak sensor maximum range is 40 GHz compared to 110 GHz for an average power sensor. Peak power meters with sensors typically also have a limited power range. The range of the P-Series power sensor is approximately -35 dBm to $+20$ dBm compared to the E9300 average power sensors, which can range from -60 dBm to $+20$ dBm. Peak power meters are also limited in rise times, pulse widths and the modulation bandwidths of the signals they can measure. These limitations can be partially controlled with the video bandwidth (VBW) setting.

Power meter video bandwidth

In the simplest terms, the VBW of a power meter gives an indication of how fast it can track signal variations of the peak power envelope. It is also an indication of the modulation bandwidth that can be accurately measured.

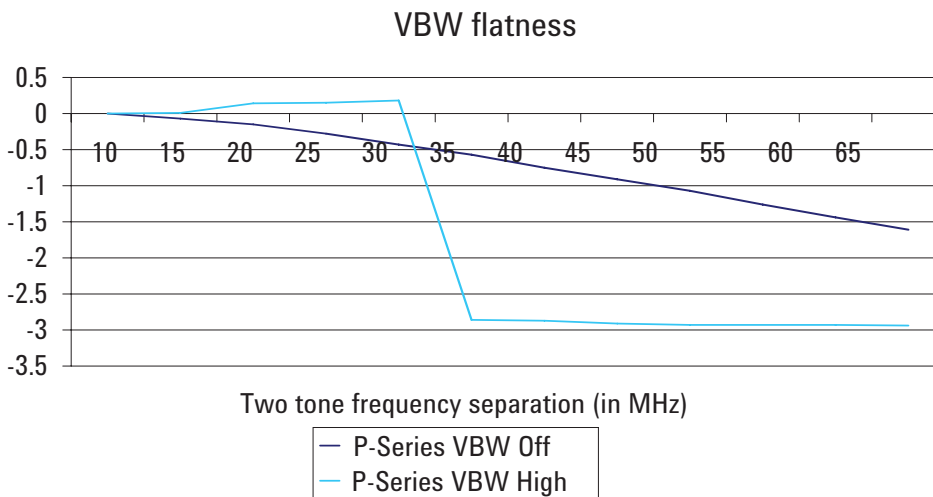

Figure 11. This chart shows the measured flatness of the P-Series power meter with the 30 MHz VBW filter turned on and off. When measuring radar signals, turning off the VBW (recommended) will maximize the bandwidth.



Figure 12. Effects of VBW on power meter measurements of a radar with fast-rising pulse edge.

When measuring pulsed radar, however, it is generally recommended that the video bandwidth filter be turned off. This maximizes the bandwidth of the meter, as shown in Figure 11, and avoids ringing that can occur due to the interaction of the sharp rolloff of the VBW filter and the rising edge of the radar pulse (Figure 12). The price paid for not using the VBW filter is degradation in the meter flatness, which VBW helps correct (Figure 11). However, for a pulsed radar signal spectrum that falls off as $\sin(x)/x$, the advantage of this correction is small and therefore best results are usually achieved without the filter. If the full bandwidth of the radar is within the maximum VBW setting then turning on the VBW filter can improve accuracy and measurement range.

Note that in the case of FM (chirped) radars the modulation bandwidth can be distinguished from the RF bandwidth. Chirps may have a very wide RF bandwidth due to frequency changes, but because the modulation does not affect the amplitude of the signal, it will not be limited by the VBW constraint of the power meter.

Overall, the power meter will have a limit on the rise time it can measure, and the minimum pulse width for which it can achieve a full peak response. For the reasons mentioned above, the fastest rise time is achieved with the VBW filter turned off. As an example, the rise time of the P-Series peak power meter and sensor is about 13 ns. The minimum pulse width for which it is able to accurately measure the pulses amplitude top is 50 ns.

Pulse frequency and timing measurements with a counter

Recently, advanced counters with pulsed RF/microwave measurement capabilities have reappeared in test and measurement product lines. These advanced counters provide a low-cost solution that is easily configured for pulse frequency (PF), pulse width (PW), pulse repetition frequency (PRF), and pulse repetition interval (PRI) measurements. Within a counter, the internal measurement engine is an advanced event timer. Instead of digitizing a signal—as in an oscilloscope—the counter makes measurements by triggering off a start event such as the rising or falling edge of a signal, at a specified amplitude. Once the start trigger occurs, a timer is started and runs until a specified stop event trigger is reached.

Using a method known as interpolation, accurate timing measurements with sub nano-second resolution can easily be obtained. For example, Keysight's 53230A universal counter provides single-shot resolution of 20 ps or better. Performing multiple measurements on a continuous signal allows the counter to further increase its resolution by using averaging to reduce random error. This type of measurement architecture provides frequency and timing measurements at a lower cost and higher resolution when compared to a scope or signal analyzer. PW, PRF and PRI are measured by sending the pulsed RF signal to a calibrated diode detector and performing timing measurements on the resulting pulse envelope. PF is measured by accurately dividing the incoming RF or microwave frequency down to a lower frequency then directing it to the internal measurement engine. Because the signal's frequency is divided down this typically limits counter PF measurements to a pulse envelope width of 500 ns or higher.

Measuring PW, PRF, PRI, and PF with a counter

The big advantage of using a counter for making PW, PRF, PRI and PF measurements is the relatively low cost of the instrument. Counters also offer another form of cost savings: they reduce the time required for test-system configuration and the actual measurements. With just a few SCPI commands, a counter can return accurate, high-resolution PW, PRF, PRI and PF measurements to the test system software at fast data transfer rates. Figure 13 shows a short sample of MATLAB code that will retrieve these measurements.

The image shows a MATLAB script window with the following code and output:

```

% Connect to 53230A, obj1.
fopen(obj1);

% Measure and store PW, PRF, and PF with 53230A
fprintf(obj1, 'CONF:PWID:BURS');
PW = query(obj1, 'READ?')
fprintf(obj1, 'CONF:FREQ:PRF (@3)');
PRF = query(obj1, 'READ?')
fprintf(obj1, 'CONF:FREQ:BURS');
PF = query(obj1, 'READ?')

% Disconnect from 53230A, obj1.
fclose(obj1);

```

Code and SCPI commands to measure and store PW, PRF, and PF

```

PW = +1.99987851562500E+005
PRF = +1.00000021296738E+003
PF = +4.00000039125104E+009

```

Measurement results

Figure 13. PW, PRF, and PF measurement code example

Other pulsed RF measurement solutions such as signal analyzers require larger command sequences and have much slower data transfer rates.

Making PF measurements on swept or chirped signals

Counters typically make PF measurements by triggering off the start edge of the pulse envelope and then begin taking frequency measurements. They will take as many measurements as possible until reaching the other edge of the pulse. A typical counter will then average all the frequency measurements together and return the result as the measured PF. This method provides maximum accuracy when working with a single carrier frequency, but not with a swept or chirped carrier. Fortunately, counters typically have capabilities that provide a fairly good measurement picture of the swept or chirped frequencies. For instance, the 53230A counter's statistical capabilities capture the minimum frequency of the sweep, maximum frequency of the sweep, standard deviation, and peak-to-peak or Allen variance measurements of the sweep. As an example, Figure 14 shows a screenshot of the 53230A making statistical measurements on a pulsed RF/microwave signal.

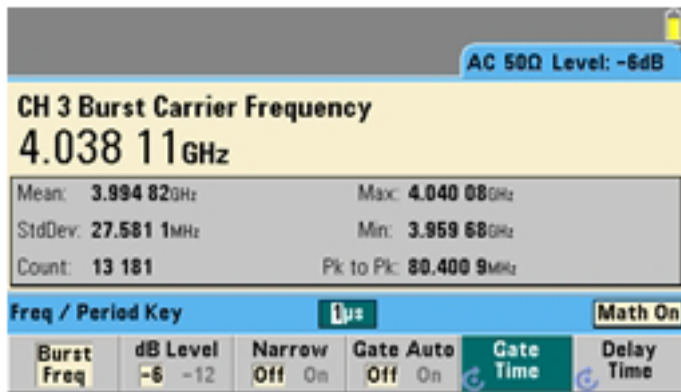

Figure 14. Screen shot showing 53230A counter statistical measurements of a swept carrier pulsed RF signal

The 53230A counter also allows you to adjust the gate time (frequency measurement window) and delay time from the edge of the pulse to the start of the PF measurement. On repeating swept pulse signals, this means you can make multiple frequency measurements at different points in the sweep to get a more comprehensive picture of the frequency components in the pulse. Figure 15 shows an example of this concept using two different sets of PF measurements. In the figure, both sets of measurements have the same gate time, but different delay times (first set of measurements has zero delay).

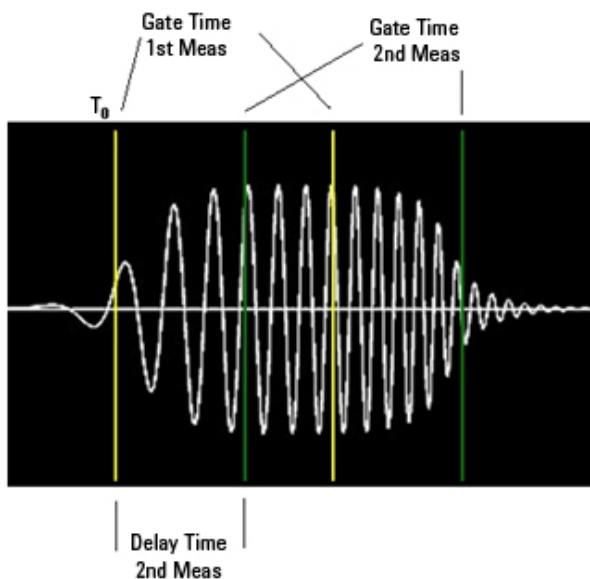

Figure 15. Making PF measurements on a swept pulsed RF/microwave signal

If we make multiple measurements at each delay time and apply statistics to each set of measurements, the counter will return multiple frequency measurements at different points in the sweep. Because we know the gate and delay times, we can accurately determine the frequency at a specific time in the pulse. With enough measurement sets with varied delay times, we could gather enough information to make accurate frequency measurements throughout the sweep. The setups and math programming to do this is beyond the scope of this application note.

Low-cost comprehensive pulse measurement system

Advanced counters with pulsed RF/microwave measurement capabilities provide a high-precision but cost-effective solution for measuring PW, PRF, PRI and PF. Counters are not designed for and cannot provide detailed pulse shape information including rise and fall time as well as signal power. These measurement gaps can be filled with another cost-effective solution, the peak power meter. A peak power meter generally provides the best accuracy for measuring signal power on pulsed RF/microwave signals. Besides signal power, peak power meters can typically make PW, PRF, PRI and pulse rise/fall time measurements. Counters can provide higher accuracy and resolution in PW, PRF and PRI measurements; however, because peak power meters digitize over the whole pulse envelope they can provide detailed pulse shape data.

These instruments complement each other well and the combined cost is much less than that of a typical pulse measurement system. For example, purchasing the Keysight 53230A counter with the channel 3 pulsed RF/microwave option, the Keysight N1911A power meter and the Keysight N1921A wideband power sensor comes in at a combined price tag of about \$20,000. Combining the counter and the wideband peak power meter creates a comprehensive low-cost pulsed RF/microwave measurement solution.

Using gapless sampling for MDA (modulation domain analysis) on a pulse signal

Besides the optional pulsed RF/microwave channel, the 53230A universal counter has two baseband channels (up to 350 MHz). Each channel offers gapless sampling capability up to 1 MSa/s. By accessing the gapless measurement timestamps from the counter, you can use software to perform MDA. Using an external calibrated power detector to eliminate the high frequency carrier makes it possible to send the pulsed signal to one of the counter's baseband channels. From there you can use the gapless time-stamped measurement capabilities to perform deep signal analysis of the noise components on the pulsed signal.

Measuring pulse power and spectrum with a signal/spectrum analyzer

The primary advantage of a signal analyzer is that it is able to measure frequency content of the radar in addition to power. This is important because an incorrect spectrum can indicate a number of problems that result in wasted power and the emission of unintended signals. In general, an improper spectral shape indicates a radar that is operating less than optimally. For example, Figure 16 shows radar signal spectra before and after adjustment to the cross-field amplifier used for the radar transmitter. The symmetry of the spectrum indicates an optimally performing radar.

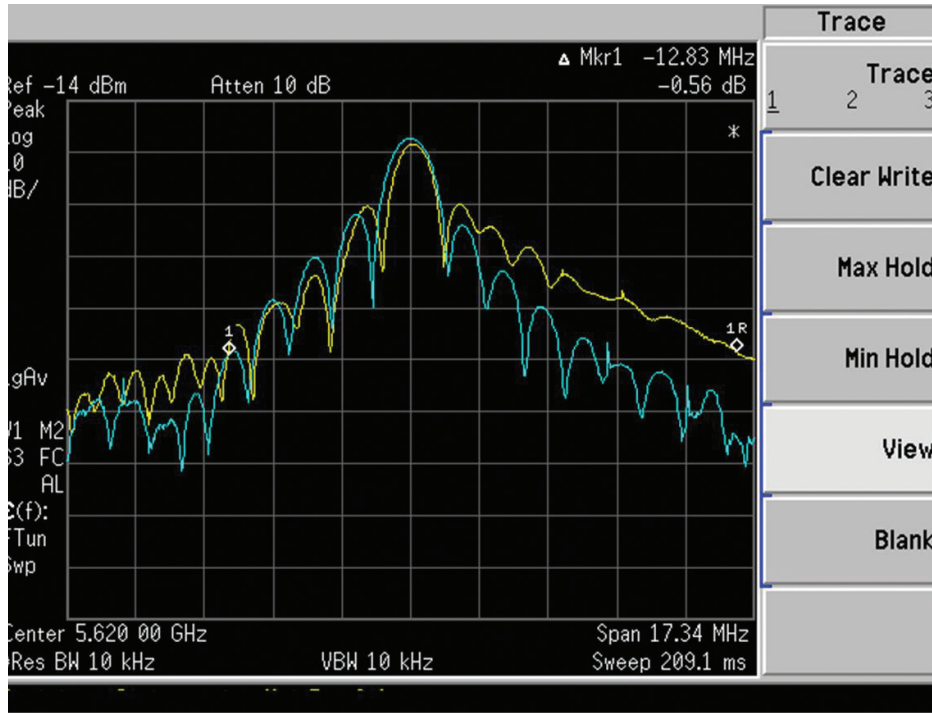

Figure 16. A signal analyzer is useful for examining the shape and symmetry of the radar spectrum. This example shows the spectrum trace before and after a timing adjustment in the magnetron.

Measuring pulsed radar with a signal analyzer is complicated by the different modes of operation that occur, which depend on the resolution bandwidth (RBW) setting of the spectrum analyzer. These variations exist when measuring any type of pulsed signal but tend to be more noteworthy when measuring the low-duty-cycle pulses commonly used with radar signals. Further, different modes in signal analyzers, namely swept versus fast Fourier transform (FFT), can behave differently when measuring pulsed signals.

This section starts with a quick review of the basic spectral shape of a simple pulsed RF signal. Next, it will examine the measurement of radar with both swept-based and FFT-based signal analyzers (including different measurement modes) and then conclude with a survey of the different built-in measurement functions included in many of today's analyzers.

PXA series high-performance signal analyzers



Maximum performance and flexibility for measuring radar

- FFT-mode for high-resolution narrowband measurements
- Swept-mode for high-speed wideband measurements & maximum dynamic range
- Built-in measurement functions for channel power, burst power, & occupied bandwidth
- Vector signal analysis with 89600 VSA software
- 160 MHz instantaneous bandwidth, 16-bit resolution
- Optional noise figure and phase noise measurement applications
- Real-time spectrum analyzer (RTSA) option provides 100% POI for signal duration as short as 3.57 μ s

Pulse spectrum review

In the time domain, multiplication of a continuous wave signal by a pulsed waveform results in a pulsed carrier. The spectrum of a pulsed signal forms a characteristic sinc function shape with a main lobe and sidelobes. From a mathematical standpoint, this can be understood by taking the Fourier transform of a rectangular waveform and then translating it to the frequency of the carrier.

As can be seen in Figure 17, the pulse width and PRF of the signal determine the characteristics of the basic pulsed spectrum. As the pulse width narrows, the width of the spectrum and sidelobes broadens. The PRF of the pulsed-RF waveform determines the spacing between each spectral component. Viewing the spectrum of the pulse can therefore provide meaningful information about the signal's pulse width, period, and duty cycle. For a basic pulsed-RF signal, the duty cycle can then be used to calculate the peak pulse power from the average power and vice versa.

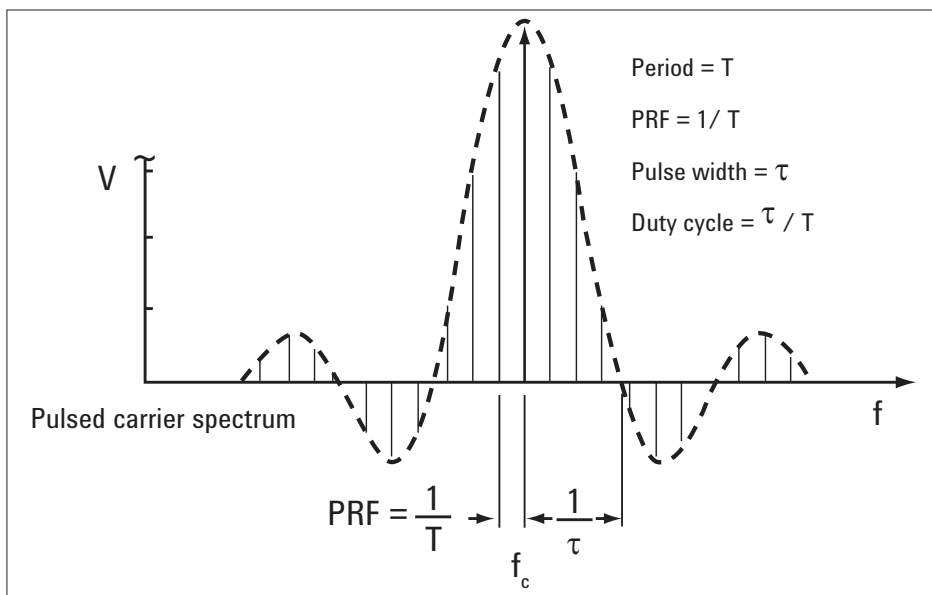

Figure 17. Pulsed spectrum

Pulsed RF measurements with a swept spectrum analyzer

Conventional spectrum analyzers are based on analog super-heterodyne swept architectures. Most modern instruments such as the Keysight PXA Series high-performance signal analyzer or MXA midrange signal analyzer employ a digital implementation of a swept architecture. This approach has many benefits in speed and accuracy over their analog counterparts. Other spectrum analyzers may work by calculating an FFT. Still others, including the PXA and MXA, employ both techniques. Each has its advantages. For example, swept analyzers usually have the best dynamic range while FFT analyzers are likely faster for computing in-channel measurements. Other differences, as they relate to measuring pulsed radar signals, will be outlined below. One advantage of a swept architecture is that most RF designers are familiar with its operation. That familiarity results in an intuitive understanding of signals from their swept spectrum measurement that is lost in a snapshot FFT spectrum.

For swept spectrum analyzers there are three primary modes of operation: line spectrum, pulse spectrum, and zero span.

Line spectrum mode

To accurately measure and view each spectral component, the resolution bandwidth filter chosen for the spectrum analyzer must have enough resolution to resolve each spectral component. The general rule is that the $RBW < 0.3 \cdot PRF$, as shown in Figure 18. When this condition is met, the measurement is often referred to as measuring in the line-spectrum mode, the true spectrum of the signal.

RBW Line < 0.3 PRF

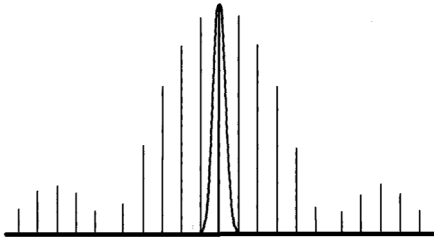

Figure 18. RBW setting on spectrum analyzer must be set less than PRF to resolve spectral components

When viewing the spectrum, the power cannot be easily measured because the level of the signal is spread into its spectral components. However, the total power, meaning average power, can be measured using the band power marker functions or a built-in channel-power measurement function of the analyzer. More information on these functions is given below. For a simple pulsed RF signal, however, the peak and average power can be extracted from the spectrum view. This is done by calculating what is known as the line spectrum desensitization factor. The peak power of the displayed spectrum is related to the peak power of the signal, assuming a near ideal pulse, by a factor of $20 \cdot \log(\text{duty cycle})$. The peak power can be determined by placing a marker on the central or highest power line in the measured spectrum and then adding, in dB, $20 \cdot \log(\text{duty cycle})$. The average power can then be determined from the peak power by subtracting the duty cycle, in log form, $10 \cdot \log(\text{duty cycle})$, as shown in Figure 19.

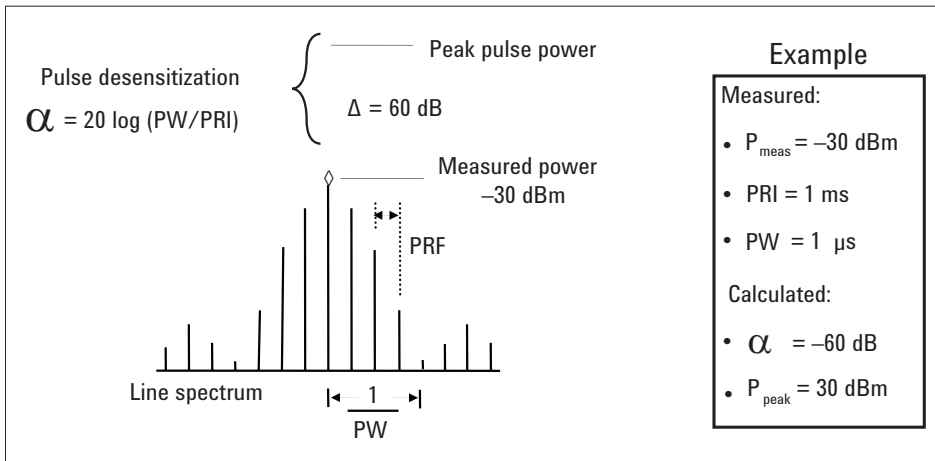

Figure 19. Calculating peak power from the pulsed RF spectrum (line mode) using the pulse desensitization factor.

If needed, the duty cycle can be determined from the spectrum because the distance between the spectral lines is equal to the PRF and the distance between the nulls of the spectrum's sinc function shape is equal to the inverse of the pulse width, as shown in Figure 16.

Note that the line-spectrum mode is valid for all signal/spectrum analyzers whether they are conventional analog swept, such as the Keysight 8566B; swept using digital implementation, such as the Keysight PXA; or use FFTs and have an equivalent RBW setting.

Pulse spectrum mode

The pulse spectrum mode applies specifically to signal/spectrum analyzers that employ swept architectures. It is what occurs when the RBW setting on the spectrum analyzer is too wide to resolve the individual spectral components of a pulsed RF signal but not wide enough to contain the majority of the spectral power. Under this condition, the spectral components within the RBW filter at any one instance are added and displayed. If the sweep time is similar to (or somewhat longer than) to the pulse period, these lines, known as a PRF lines, will be displayed across the screen and have a sinc function shape similar to that of the line-spectrum view. Note, however, that these are not spectral lines. Their location, though on frequency axis, has no specific frequency domain meaning and they will move around during each sweep. A PRF line appears each time a pulse occurs. The space between each line is the space or distance in time that the analyzer sweeps between each pulse when no power is present at the signal analyzer input. Thus, in reality the spacing between the lines is directly related to the period of the signal. If the sweep time happens to be fast compared to the pulse period, the PRF lines will be spaced too far apart for a good view of the signal. In this case, the common practice is to increase the sweep time so that the PRF lines occur more closely together on the display and can be viewed.

Many signal analyzers include a marker feature that reads out the time difference between marker occurrences instead of frequency. Using this feature, the pulse period can be measured directly, simply by computing a delta-time marker between two adjacent PRF lines.

Two methods can be used to determine the operating mode of the analyzer: pulse-spectrum or line-spectrum. First, change the RBW. The amplitude of the displayed signal will not change if the analyzer is operating in the line-spectrum mode. If the analyzer is operating in the pulse-spectrum mode, the displayed amplitude will change because it is a function of RBW. Second, change the sweep time. The lines representing spectral components of the signal will not change with sweep time in the line-spectrum mode. In pulse-spectrum mode, the spacing between PRF lines will change as a function of sweep time.

If the sweep time is set to be much longer than the pulse period, eventually the distance the sweep moves between pulses will become small relative to the resolution of the display. The resulting display with peak detector will show an outline of the pulse spectrum envelope, as shown in Figure 20. This display can be used to conveniently measure the pulse width by using the minimum peak search function and measuring the spacing between the nulls as shown in Figure 17. This can be done because the side lobes are the same for the line-spectrum (true spectrum) and pulse-spectrum modes.

$$\alpha_p = 20 \cdot \text{Log}(t \cdot B_{imp}) = 20 \cdot \text{Log}(t \cdot K \cdot \text{RBW})$$

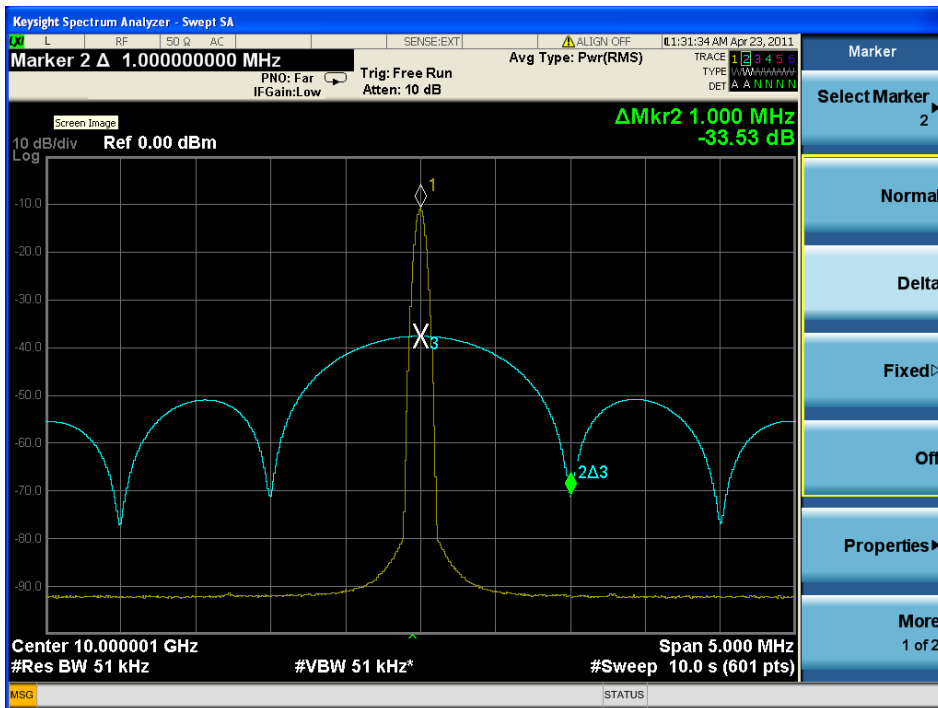

Figure 20. Pulse spectrum mode view: pulse modulation turned on and off.

Though the technique is used less often today, both the peak power and the average power can be determined from the pulse spectrum. For some corner cases in which very narrow pulses are being used, it's possible that this technique may be the best viable option.

The maximum displayed level of the signal in the pulse-spectrum mode is related to the impulse response of the spectrum analyzer's RBW filter. This will vary depending on the model and make. For example, the Keysight PXA spectrum analyzer's narrower RBWs are eight-element Gaussian filters with impulse bandwidth of 1.48 times the RBW. ($B_{imp} = 1.48 \cdot \text{RBW}$ for $\text{RBW} \leq 4 \text{ MHz}$) Using this information, the peak power can be determined by calculating a desensitization factor and adding it to the measurement. The pulse mode desensitization factor is equal to $20 \cdot \text{log}(\text{pulse width} \cdot B_{imp})$. An example is shown in Figure 20.

Zero-span measurements

In addition to making frequency-domain measurements, the signal analyzer provides a zero-span mode for time-domain measurements. In the zero-span mode, the signal analyzer becomes a fixed-tuned receiver with a time-domain display similar to that of an oscilloscope, but it instead displays the pulse envelope as shown in Figure 21. Modern signal analyzer also have various trigger modes to provide a stable display. Trigger delay controls allow you to position the pulse envelope for convenient measurements of pulse width, peak power, on-off ratio, and rise time.

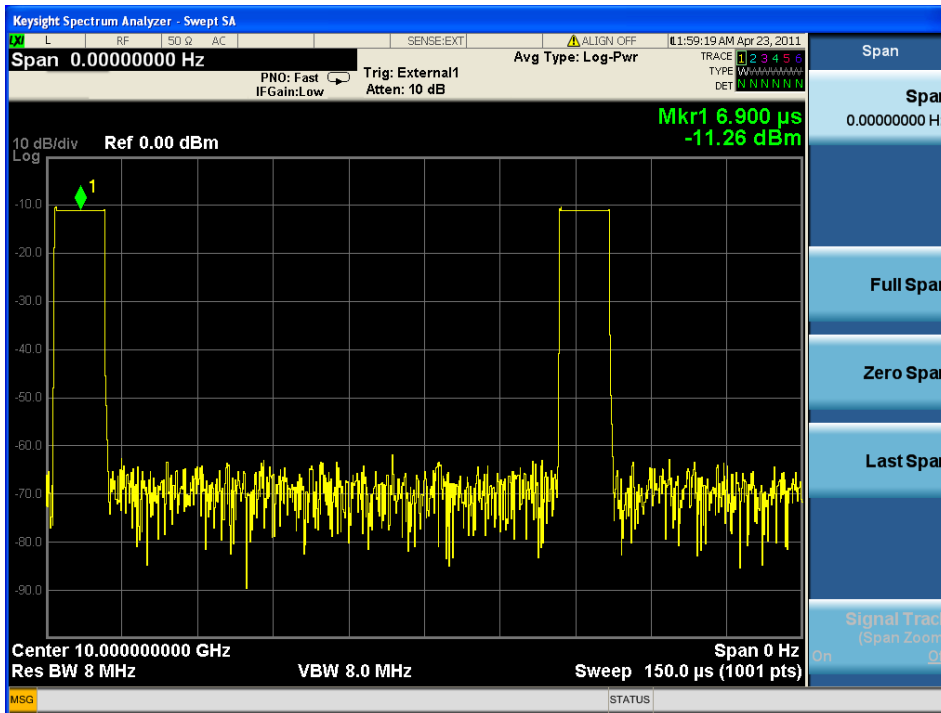

Figure 21. This example of zero-span mode gives a time-domain view of the envelope of the radar pulse. It is a convenient way to measure pulse characteristics when the bandwidth of the radar signal is much less than the RBW of the spectrum analyzer.

Zero span makes it easy to measure important pulse parameters such as rise time and amplitude droop that are impossible to measure in the frequency domain. However, for a valid zero-span measurement, the RBW must be set such that all (or at least a majority) of the signal power is contained within the RBW. More specifically, to accurately measure the maximum power of a pulse, the analyzer filter must be able to settle between measurements. The following condition must be met:

$$\text{Pulse width} > \text{settling time of analyzer} \cong 2/\text{RBW}$$

$$(\text{settling time} = 2.56/\text{RBW} \text{ for the PXA and MXA signal analyzers})$$

To accurately measure the rise and fall time, the analyzer's settling time must be faster than the signal under test. A general rule is:

$$\text{Rise time of pulse} \gg \text{rise time of analyzer} \cong 0.7/\text{RBW}$$

In the case of the PXA signal analyzer, the maximum resolution bandwidth is 8 MHz in the standard spectrum analysis mode. If a wider bandwidth is needed, two options exist for the PXA. The first is an optional fast rise time log video output. With this option a user can use an oscilloscope to analyze the video output signal from the PXA and measure rise times of less than 15 ns.

The other option is to use the PXA vector signal analysis (VSA) mode and the 89600 VSA software. In the VSA mode, the PXA has an equivalent video bandwidth of 140 MHz and the ability to measure the time-domain envelope of the signal in a manner similar to zero span. Using this mode, the PSA can measure rise times of approximately 15 ns.

Pulsed RF measurements with analyzers that compute FFT

As mentioned above, some signal analyzers use FFT to compute spectra in a manner similar to that of a VSA. Analyzers that use FFT techniques have advantages and disadvantages when compared to swept analyzers. Swept analyzers have advantages in sensitivity and wide-span measurements. FFT analyzers can be faster for measuring radars with bandwidths less than the analyzer's maximum FFT analysis bandwidth. FFT-based signal/spectrum analyzers can also perform VSA measurements (if the software is implemented) because phase information is maintained. However, for reasons covered below, FFT analyzers tend to be inadequate for measuring wideband radar or radar with low duty cycles. Some spectrum analyzers such as the PXA and MXA include both swept and FFT modes and automatically switch between them depending on measurement settings. The analyzer can be set to automatically optimize for speed or dynamic range or forced to remain in either FFT or swept mode.

FFT-based spectrum analyzers typically have a user interface designed to have a look and feel similar to that of a traditional swept analyzer. A casual user may not even recognize that they are using FFT techniques rather than traditional spectrum sweeps. However, the differences become apparent when measuring pulsed RF signals.

Like a vector signal analyzer, the FFT-based spectrum analyzer can be fast at measuring signals whose entire bandwidth is contained within a single FFT (i.e., contained within its analysis bandwidth). With this condition met, the FFT signal analyzer is essentially equivalent to a VSA though typically without as many measurement functions and displays. You can learn more about how a VSA works in the VSA section, below.

When the span of interest is wider than the analysis or FFT bandwidth of the analyzer, the FFT-based spectrum analyzer calculates the spectrum by taking multiple FFTs at different frequencies and concatenating the results. This technique is sometimes called stitching because the analyzer computes the spectrum one section at a time, step tuning to a different frequency for each section, and patching them together. Depending on the speed of the analyzer, one may be able to see each section of the spectrum appear as it is computed

N9051A pulse measurement software for signal analyzers

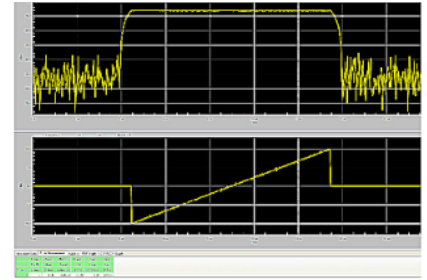

The N9051A software adds pulse measurement capabilities to Keysight X-Series signal analyzers:

- Analyze up to 1,000 continuous pulses at a time and up to 200,000 statistically (extended analysis option)
- Use multiple views to perform concurrent analysis of power vs. time, frequency vs. time, phase vs. time or power vs. frequency
- Measure PRI/PRF, pulse width, duty cycle, rise/fall, droop, overshoot and ripple (base capabilities)
- Characterize pulse-to-pulse phase, bandwidth, start/stop frequency, chirp slope, chirp deviation, and more, with phase and frequency option

A similar solution is the W2605A oscilloscope signal analyzer (OSA) software, which adds pulse and modulation-domain capabilities to 9000, 90000 and 90000 X-Series scopes (page 52).

If the condition for line-spectrum mode is met ($PRF < 0.3 RBW$) then there is no difference in the result for the traditional swept or FFT analyzer. However, if these conditions are not met, FFT-based analyzers will behave quite differently than swept analyzers. In this case, the FFT analyzer will not display the PRF lines seen in the swept analyzer. Rather, the data displayed will depend on the probability of intercept between the FFT acquisitions and the pulses. Because FFT analyzers require time to retune and capture when measuring over wide spans, they may have difficulty intercepting low-duty-cycle pulses, resulting in blank or sporadic measurement results. When the speed of the analyzer and duty cycle of the pulse are such that the signal is intercepted, then the result may appear as disjointed segments of the spectrum envelope, as shown in Figure 22.

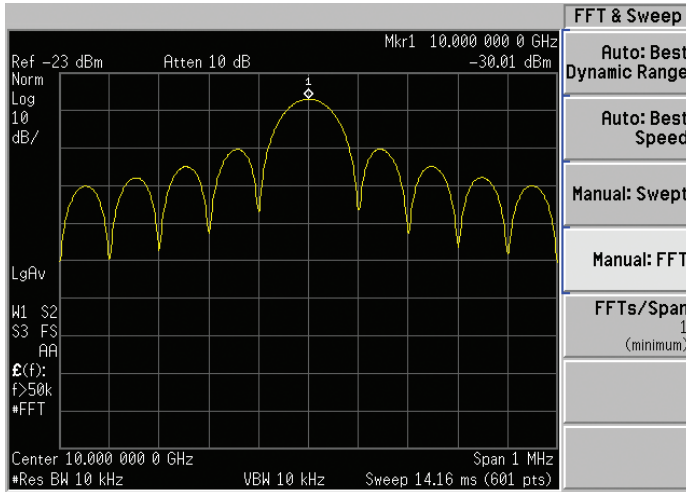

FFT analyzer will display pulse envelope rather than PRF lines as measured on a swept analyzer.

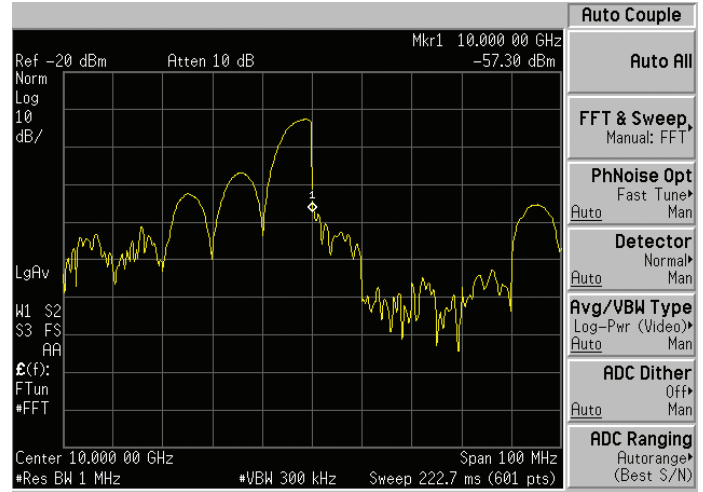

The measurement result may be sporadic when measuring wide band radar signals because the FFT analyzer is required to retune between FFT calculations.

Figure 22. A spectrum analyzer that computes FFTs will behave differently than a swept analyzer when the RBW is greater than PRF. Instead of PRF lines, the spectrum analyzer will display the pulse envelope.

In the best case, the complete RF spectrum envelope will be displayed rather than PRF lines. Some spectrum analyzers using FFT may include settings such as FFT dwell time, FFT length, or triggering to improve the ability to capture and measure pulses. These settings may be tied to a sweep-time control to mimic the user interface of a traditional analyzer but in actuality it's the FFT length, dwell time, or number of averages that is being modified because the analyzer is not sweeping in a traditional sense. Generally, FFT-based analyzer modes are not the best choice for measuring radar signals whose bandwidth requirements are beyond the FFT analysis bandwidth of the analyzer.

Built-in measurements

Today's modern spectrum analyzers include many built-in functions and capabilities that can simplify and enhance radar measurements. Several of these features are highlighted here.

Channel power

The channel-power function is designed to measure the average power across a given frequency band. It is a common measurement that is frequently used to measure many different types of signals. Spectrum analyzers use different techniques for making channel-power measurements. The most common way, which is usually the most accurate, is the integration bandwidth method. The analyzer essentially integrates the power as it sweeps across the given integration bandwidth. Typically, the measurement uses the analyzer's averaging detector. For the best accuracy, the RBW should be small compared to the integration bandwidth. However, it does not matter if the conditions for line spectrum or pulse spectrum are met. Examples of channel-power measurements of a radar signal are shown in Figure 23.

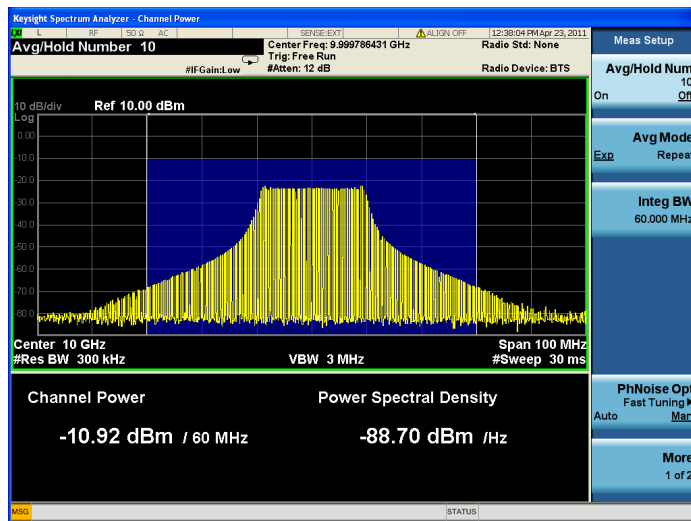

Chirped radar

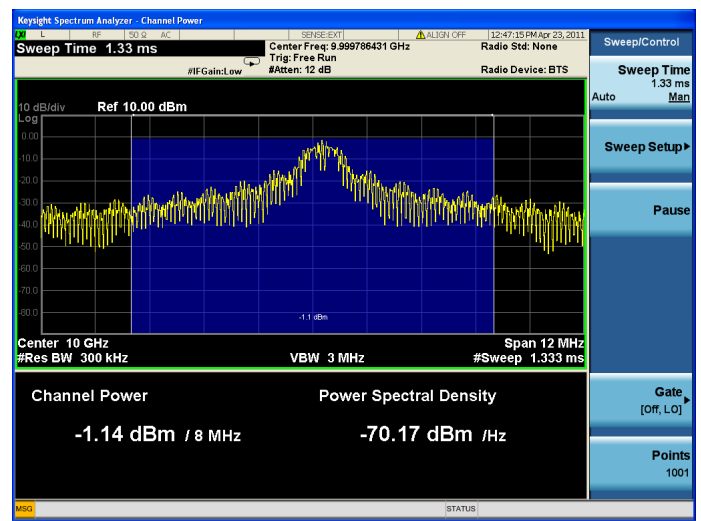

7-bit Barker code

Figure 23. Channel power measurement of radar signals performed on a spectrum analyzer. Results are equivalent to average power.

The channel-power measurement can be especially useful for modulated, chirped, or pulsed signals that are more complex and vary their PRF or pulse width. The spectra of these signals are more complex and, as a result, the power cannot be as easily derived from the spectrum as was explained earlier for a simple RF pulse. Figure 23 shows channel-power measurements of chirped and pulse-coded radars. Note that the spectral shape is no longer a simple sinc function shape because the modulation on the pulse dominates in shaping the spectrum.

Occupied bandwidth

The occupied bandwidth (OBW) measurement automatically calculates the bandwidth in which a specified percentage of the power is contained. The OBW of the signal is often determined based on the bandwidth for which 99% of the signal's power is contained, as shown in Figure 24.

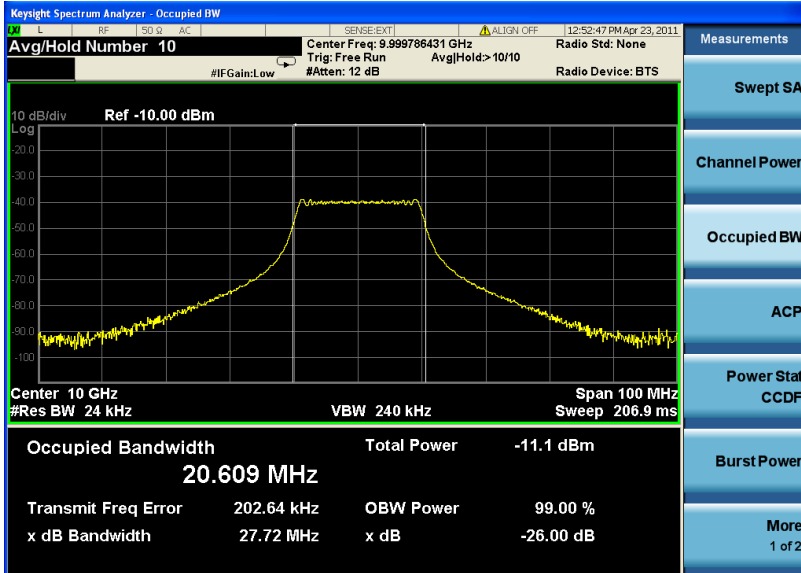

Figure 24. This is an example of an occupied bandwidth measurement on the PXA spectrum analyzer. Bandwidth for which 99.00% of the signal power is contained is automatically measured and reported.

Burst power

The burst-power measurement is an automated zero-span measurement. Rather than integrating the power in the frequency domain (as is done in the channel- power measurement) the burst-power measurement integrates the power across a defined time slot or gate and is essentially equivalent to the gated power measurements discussed earlier in the power meter section. The measurement often uses a burst-power trigger (provided on some signal analyzers such as the PXA) that automatically finds and triggers on the burst (or pulse), as shown in Figure 25. This can be very useful for radar because it is a direct measurement of the pulse power. Its limitations, however, are the same as those for zero span: the RBW filter must be wide relative to the occupied bandwidth of the signal.

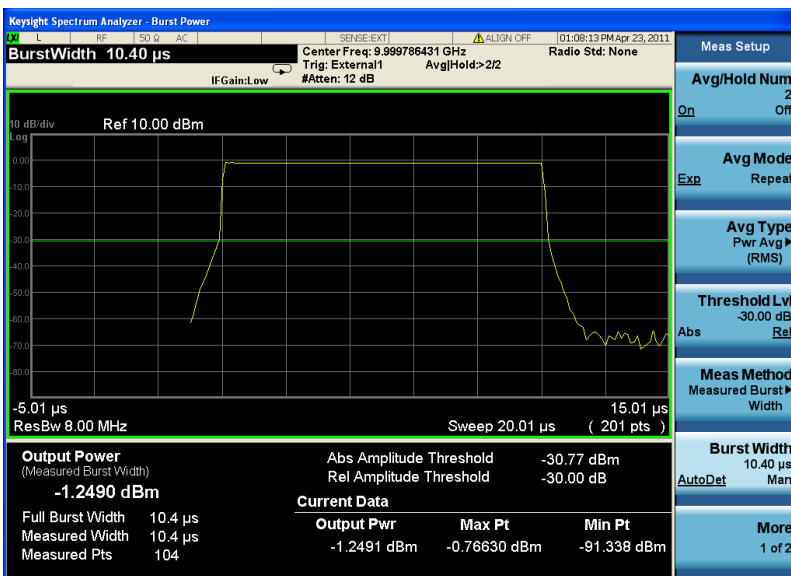

Figure 25. This is an example of burst-power measurement from the PXA signal analyzer. Burst power and pulse width are automatically measured in zero-span mode.

Pulse measurement software

Thus far we have focused on making pulse measurements with a signal analyzer. It is also possible to use software that acquires raw data from a signal analyzer or oscilloscope and then makes automated pulse measurements (Figure 26).

The Keysight N9051A pulse measurement software provides easy-to-use, time-oriented measurements of pulsed RF or microwave signals in signal analyzers and oscilloscopes. It automatically finds pulse edges in time and then measures the following parameters:

- Maximum, Minimum, and Average Amplitude
- Pulse Droop, Overshoot, and Ripple
- Top (median power of “on” state)
- Base (median power of “off” state)
- Rise and Fall Time
- Pulse Width
- Duty Cycle
- PRF (Pulse Repetition Frequency)
- PRI (Pulse Repetition Interval)
- Off Time
- Edges
- PDF (Probability Distribution Function)
- CDF (Cumulative Probability Function)
- CCDF (Complementary Cumulative Probability Function)

The pulse analysis software also supports popular features such as ‘Maximum Hold,’ ‘Minimum Hold,’ and ‘Average’ signal levels, as well as a variety of signal markers.

It supports a ‘Zoom’ feature that allows detailed examination of any particular pulse depicted on the display. The various algorithms determine pulse characteristics according to methods defined in IEEE Standard 181-2003.

The N9051A software supports the Keysight X-Series signal analyzers as well as Keysight PSA analyzer and Keysight 8000, 80000, and 90000 Series Infiniium oscilloscopes. The software can reside inside an X-Series signal analyzer or an Infiniium oscilloscope and is controlled through an attached keyboard and mouse. One nice feature of the N9051A pulse analysis software is that it automatically configures the signal analyzer or oscilloscope to optimize the settings for maximum instrument accuracy.

The diversity of hardware allows measurements of pulses with center frequencies of up to 50 GHz and bandwidths up to 32 GHz. The software includes time and spectrum displays with the ability to easily zoom in for detailed visual analysis. It also includes common signal analyzer capabilities such as power-unit conversions, trace math and markers. In addition, statistical analysis can be performed with PDF, CDF and CCDF displays. The software can also output the measurement results to applications such as Microsoft Excel for advanced and user-defined analysis.

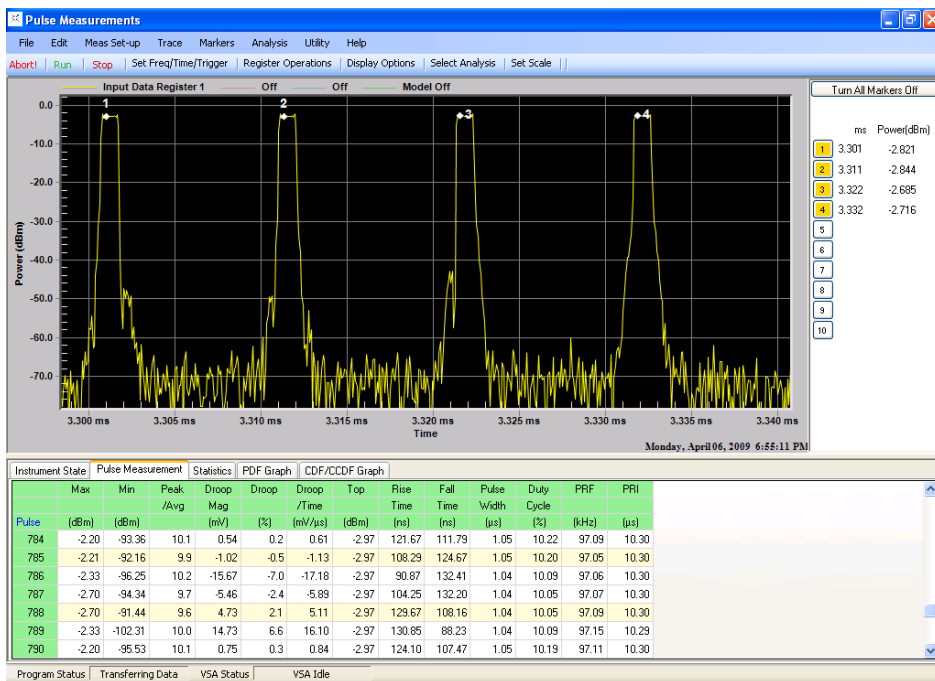

Figure 26. Running on a scope or signal analyzer, the N9051A software provides analysis of pulse parameters. This trace shows the results of zooming in and analyzing pulse-to-pulse amplitude variations with markers. It also shows results from automatic analysis of pulse metrics over 950 consecutive pulses.

Measuring with a vector signal analyzer

Unlike a spectrum analyzer, a vector signal analyzer captures the phase and magnitude information of the measured signal and uses this information to perform more advanced analysis. Vector signal analyzers are typically very flexible and can display results in the time, frequency and modulation domains. (For detailed information on how a vector signal analyzer operates, see Keysight Application Note, *Vector Signal Analyzer Basics*, literature number 5989-1121EN.) [6]

A vector signal analyzer does not sweep across a wide frequency range like a spectrum analyzer. Most vector signal analyzers operate by tuning to a specific frequency, conditioning the signal, down converting, digitizing, and processing the signal. Some vector signal analyzers skip the analog downconversion stage and directly digitize the baseband, IF or even RF signal after conditioning.

The primary limitation of a vector signal analyzer is its analysis bandwidth (sometimes referred to as information bandwidth or FFT bandwidth). To properly analyze a signal, virtually all of the signal power must be contained within the analysis bandwidth of the instrument. The analysis bandwidth of a vector signal analyzer is usually dictated by the analog-to-digital converter (ADC) sampling rate and Nyquist's law. The dynamic range limit of the analyzer is usually limited by the bit level of the ADC, although the number of effective bits may vary noticeably between instruments with the same bit depth, depending on the quality of the ADC, sophistication of dithering techniques, image correction, and over-sampling techniques.

There are a variety of vector signal analysis solutions available with varying performance constraints and tradeoffs in bandwidth, sensitivity, memory, and frequency range. (See Keysight product overview: *Hardware Measurement Platforms for the Keysight 89600 Series Vector Signal Analysis Software*, literature number 5989-1753EN). Many of today's modern instruments include dual functionality and operate as both a spectrum analyzer and a vector signal analyzer, as is the case with the Keysight X-series and PSA analyzers, or as an oscilloscope and vector signal analyzer as with the Keysight VSA80000 Series. Keysight VSA software can also be extended to work with logic analyzers to analyze signals in digital form or to work in software simulation environments such as Keysight ADS or MATLAB.

Measuring across formats and domains

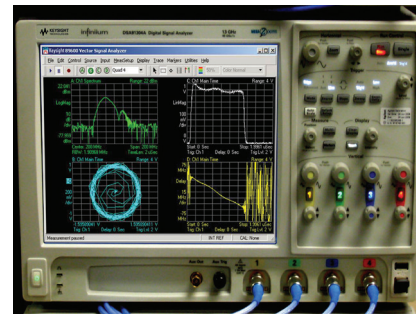

The signal processing used in radars requires development and validation in the digital domain. It is also important to evaluate and compare the effects of these algorithms (and associated analog hardware) in the digital and analog domains.

To meet this need, the 89600 VSA software is compatible with more than 30 platforms, and it can run on a PC or inside certain Windows-based Keysight instruments. Measurements can be performed on FPGAs with logic analyzers, at the IF or RF level with oscilloscopes, and along the RF exciter and receiver chains with signal analyzers. In all cases, the VSA software runs transparently alongside the native capabilities of each instrument. This approach enables precise measurements of high-level VSA metrics across a variety of signal formats and physical interfaces.

In addition to direct measurement to 63 GHz with a scope, our family of wide-band downconverters brings the bandwidth of high-performance oscilloscopes to the operating frequencies of most radars. Using a four-channel oscilloscope in conjunction with these downconverters, VSA measurements can be made on up to four different frequency-coherent or frequency-translating devices with up to 1.5 GHz of measurement bandwidth.

The section below explains how the vector signal analyzer measures the power spectrum of a pulsed RF signals and then discusses other useful VSA measurements, such as time-domain characteristics, time-gated measurements, gap-free or live measurements, and spectrogram. It also includes examples of measuring the chirp linearity and pulse coding of more complex radar waveforms.

Measuring the radar spectrum with a vector signal analyzer

A vector signal analyzer calculates the spectrum by performing an FFT. The analyzer will calculate the FFT of whatever portion of the signal is within its measurement time window. Therefore, a best practice for achieving good spectrum results of a pulsed RF signals is to include multiple pulses within the measurement window so that the FFT calculation captures the repetitive characteristics of the signal, as shown in Figure 27. However, one attractive capability of a vector signal analyzer is that it can perform single-shot analyses. This can be very useful for radar because it gives the analyzer the capability of analyzing single pulses or transient events, as in Figure 28. To be clear, however, the nature of the FFT calculation should be understood to fully appreciate the results that the analyzer displays.

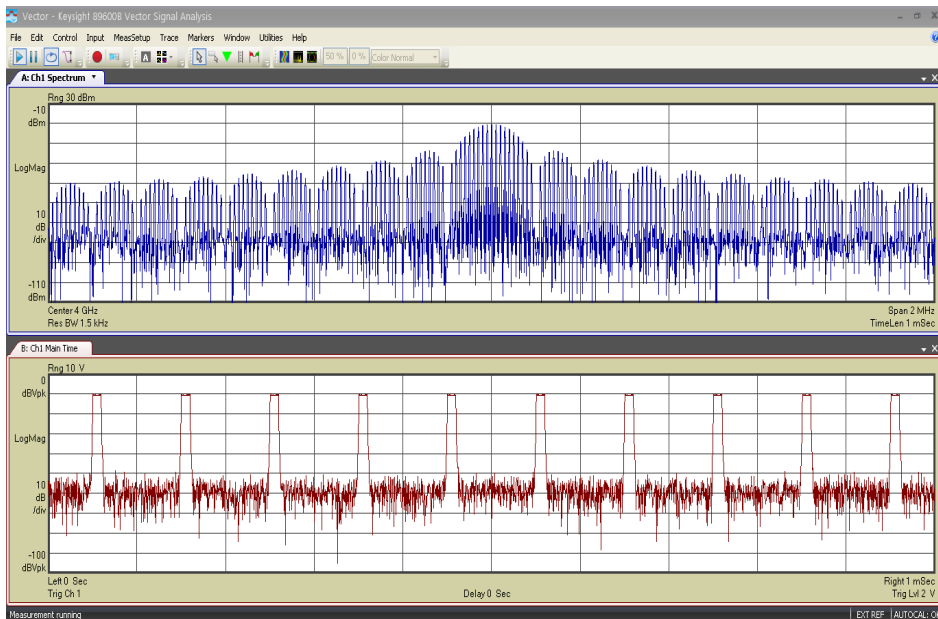

Figure 27. Vector signal analyzer measurement of radar pulse showing spectrum and time domain view.

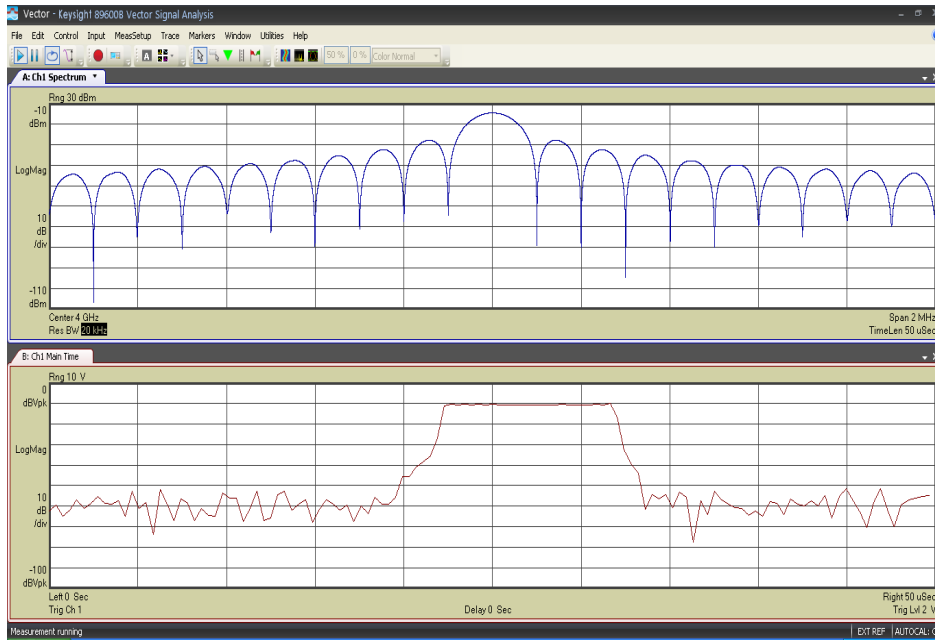

Figure 28. A vector signal analyzer has the ability to provide spectrum analysis of a single pulse.

Inherent in an FFT is the assumption that the time-domain signal used in the calculation repeats. If you capture a single time event and use it to calculate an FFT, the resulting spectrum result is actually the spectrum of a repeating version of the event, as shown in Figure 29.

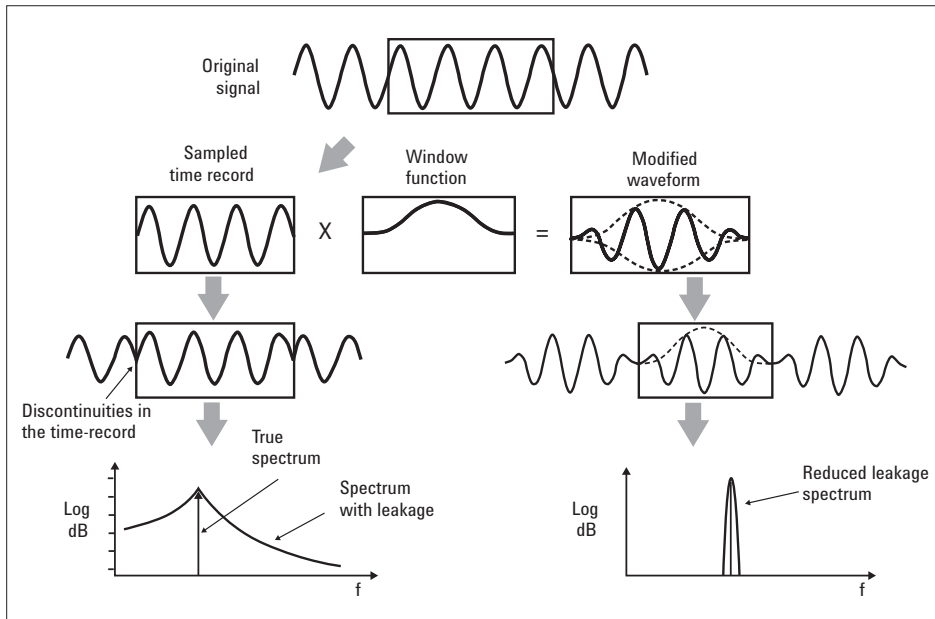

Figure 29. FFT analysis done in a spectrum analyzer or vector signal analyzer assumes a repeating signal. To minimize effects of discontinuities in the signal, a windowing function is used.

Vector signal analyzer windowing function

With a vector signal analyzer, each measurement update captures a portion of the time-domain signal and uses it to compute the FFT. An inherent problem is that the successive time captures may start and end at different voltage-level points in the signal. Because the FFT assumes a repeating signal, a discontinuity (sudden change in voltage) results. This discontinuity will show up as leakage in the spectrum. To mitigate this problem, vector signal analyzers utilize a windowing function that operates on the waveform to minimize the discontinuity. (See Keysight Application Note 150-15, *Vector Signal Analysis Basics*, literature number 5989-1121EN for detailed explanation.) [6] Even though this windowing function changes the shape of the time-domain waveform, its shape (typically a Gaussian or Hanning window) is designed to have a minimal effect on the spectral result. However, it can have some impact on the accuracy of the spectrum. Different types of windowing functions are typically made available in order to trade off performance objectives in frequency accuracy, amplitude accuracy, or sensitivity.

Pulsed or burst signals usually make it possible to set the start and stop of the measurement window in between the pulses when no signal is present, thus avoiding discontinuities. Most radar signals, as it turns out, have an added advantage in that they tend to be self-windowing due to the symmetry of the signals. The best results for radar signals are therefore achieved by using the uniform window function that does not alter the time-domain waveform.

Figure 30 shows an example of a chirp radar spectrum with two different windowing functions. In this case, Gaussian window function distorts the spectrum since the pulse is occurring near the beginning of the measurement time window—and this is where the windowing function has the most effect on the signal. The same measurement using a uniform window gives a much better result.

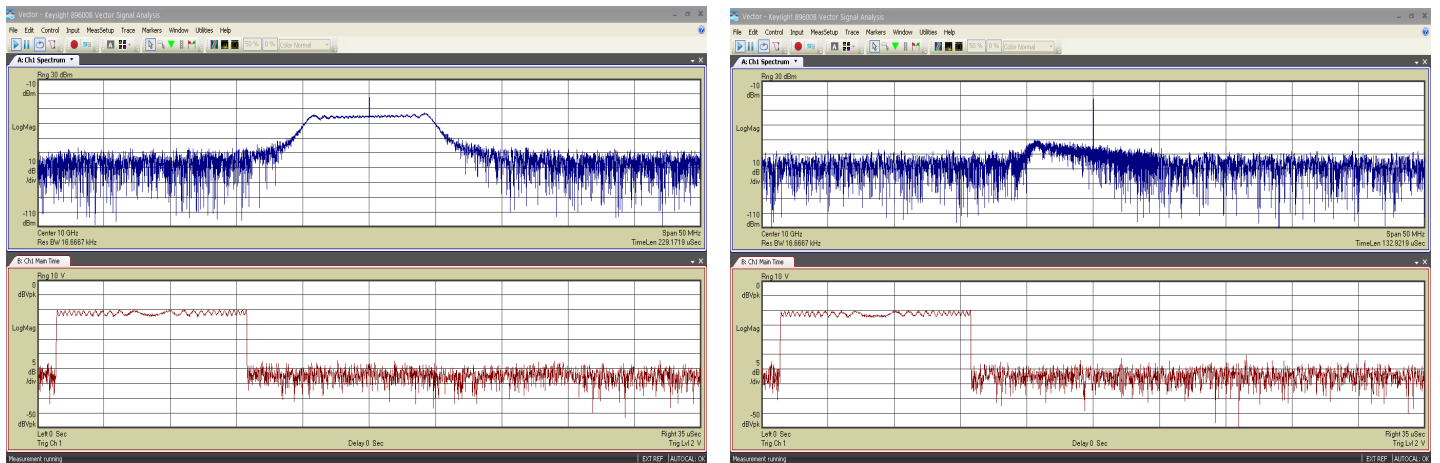

Figure 30. This compares a radar measurement made on a VSA using different windowing functions, uniform (left) and Gaussian (right). The Gaussian window distorts the spectrum because the pulse occurs near the start of the measurement time window. Because pulsed radar signals are self-windowing, the uniform window function should be used to ensure the best accuracy.

Measuring power and pulse characteristics with a vector signal analyzer

Similar to a spectrum analyzer, the average power and peak power can be determined from the spectrum result. However, the proper measurement conditions must be met and understood to ensure an accurate measurement. The most straightforward way to ensure accurate results is to set the analyzer to measure in the line-spectrum mode with an RBW of less than $0.3 \cdot \text{PRF}$. This condition ensures that the analyzer will resolve each spectral component. Note that since the vector signal analyzer's RBW setting is tied to the measurement time, setting the RBW to match line-spectrum mode will automatically result in a longer measurement time, essentially having the same effect as including several pulses in the FFT calculation, as shown in Figure 23. The average power and peak power for a simple pulsed RF signal can be determined using the same method as the line-spectrum mode in the spectrum analyzer. This is not normally done, however, because a vector signal analyzer allows other measurement windows to be used to make these measurements directly in the time-domain view.

Band power (similar to channel power) and OBW functions are also typically included with a vector signal analyzer and typically provide the same capabilities as the equivalent functions in a signal analyzer. Additional measurements such as complementary cumulative distribution function (CCDF), spectrogram, and time-gated spectrum are also available. To achieve accurate results, the spectra must be calculated from a representative time-domain sample of the waveform. If only a small sample of the signal relative to the period is being used to calculate the spectrum, the displayed level of the spectrum may not reflect the true power level or the correct spectral characteristics of the signal. This can be resolved by either increasing the FFT measurement time to include several pulse periods or setting the RBW to meet the line-spectrum mode.

Keysight 89600 VSA software



Flexible signal analysis of frequency, time and phase

- Supports multiple platforms including signal analyzers, oscilloscopes and logic analyzers
- Ultra-wide bandwidth analysis with 90000-series oscilloscope
- Gap-free analysis with record playback feature
- Spectrogram

Measuring time-domain characteristics with a vector signal analyzer

When measuring radar signals with a vector signal analyzer, it is intuitive to measure signal characteristics such as average power, peak power, pulse power, duty cycle, pulse width, pulse period, and pulse shape in the time domain.

With the 89600 VSA software, time-domain and frequency-domain measurements can be displayed simultaneously. This makes it easy to correlate the time-domain and frequency-domain views of the signal.

A variety of time-domain display options typically exist for a vector signal analyzer. Figure 31 shows the display of a radar chirp using the PXA Series spectrum analyzer with 89600 VSA software. Time-domain displays and markers can be used to readily measure parameters such as pulse power, peak power, pulse width, pulse period, rise time, frequency versus time or group delay, pulse-to-pulse phase continuity, and pulse droop.

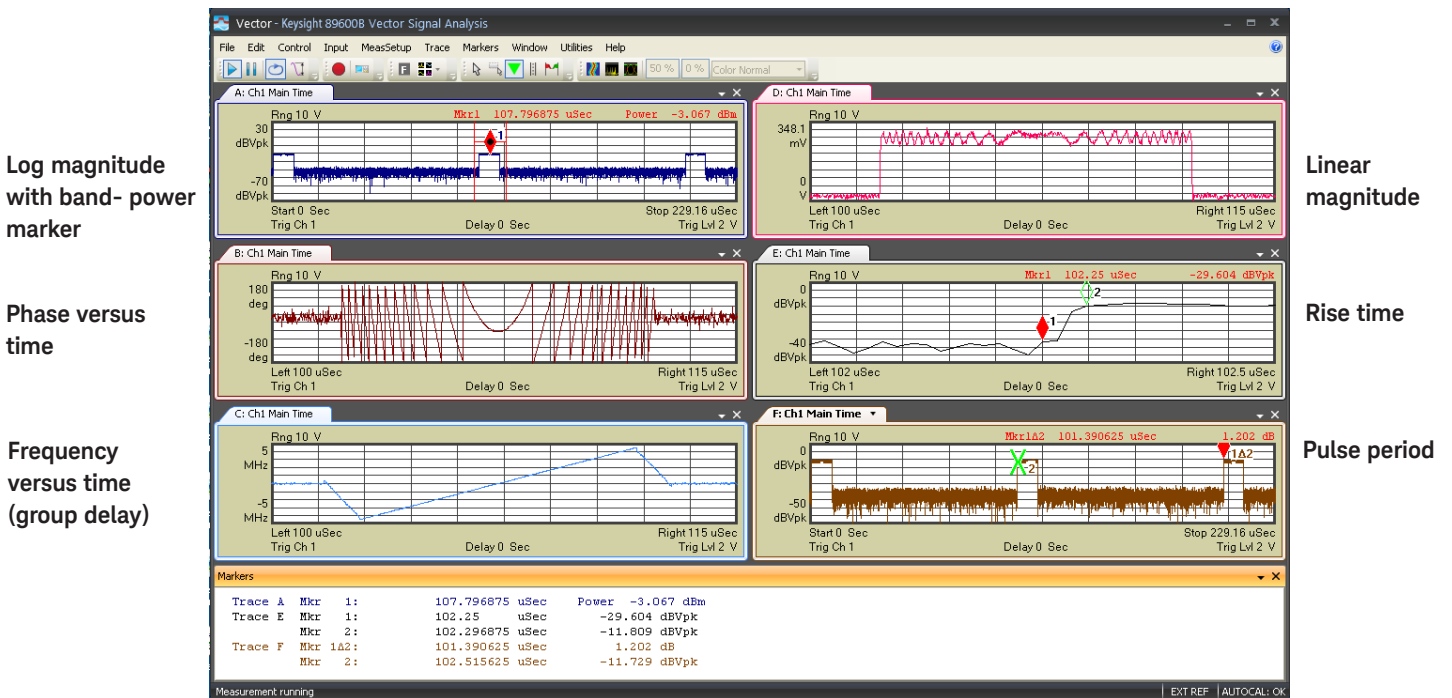

Figure 31. Time-domain measurements on chirp radar using a vector signal analyzer.

Time-gated analysis of pulsed RF signal on vector signal analyzer

Many vector signal analyzers have the ability to perform time-gated analysis. These analyzers use FFT time-gating technique in which only the samples collected during a defined timeslot are used in the FFT calculation. The unique advantage to the vector signal analyzer is that it is able to perform single-shot time-gated analysis. This is useful for examining the spectral characteristics of an individual pulse, portion of a pulse, or transient. The time-gated measurements in the 89600 VSA software are convenient, intuitive, and simple to perform through dragging and dropping the gate onto the time-domain display of the waveform. Figure 32 shows the time-gated spectrum of a simple RF pulsed radar. Remember that the spectrum displayed is in reality the spectrum of a repeating version of the waveform capture in the time record gate.

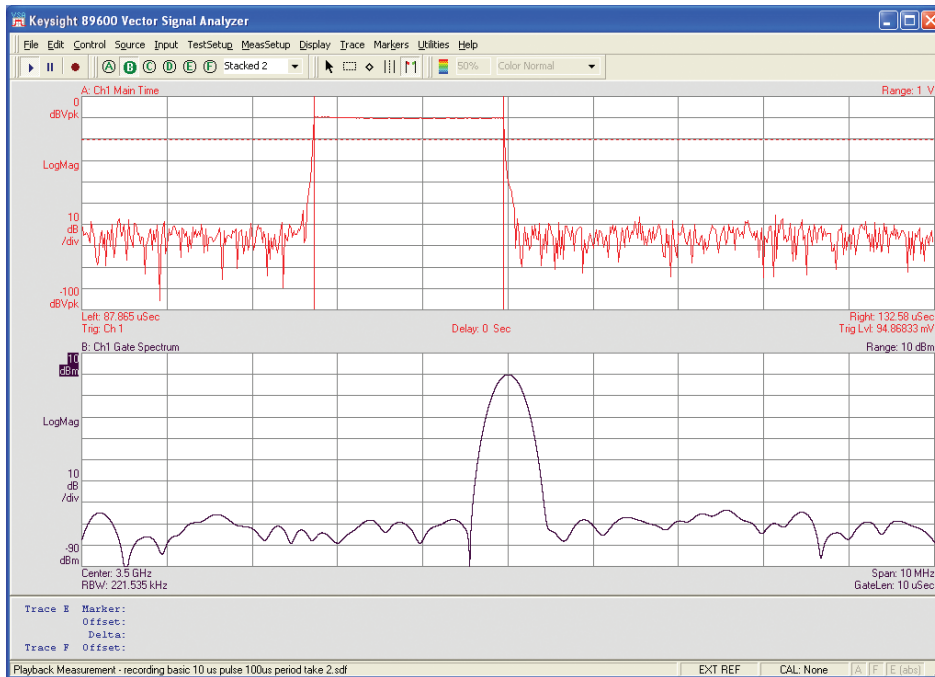

Figure 32. This is a time-gated measurement of simple RF pulse showing CW spectrum of signal when pulse is on.

Spectrogram

Spectrograms are made up of a sequence of ordinary spectrum measurements, and each spectrum measurement is compressed to a height of 1 pixel row on the display and the amplitude values of each spectrum are encoded with color. This produces a display of spectrum versus time, containing hundreds or even thousands of spectrum measurements.

The spectrogram allows easy visual recognition of the major signal characteristics. Figure 33 shows an example of measuring a frequency-agile signal with the Keysight 89600 VSA software. The measurement is useful in characterizing the frequency behavior of signals over time.

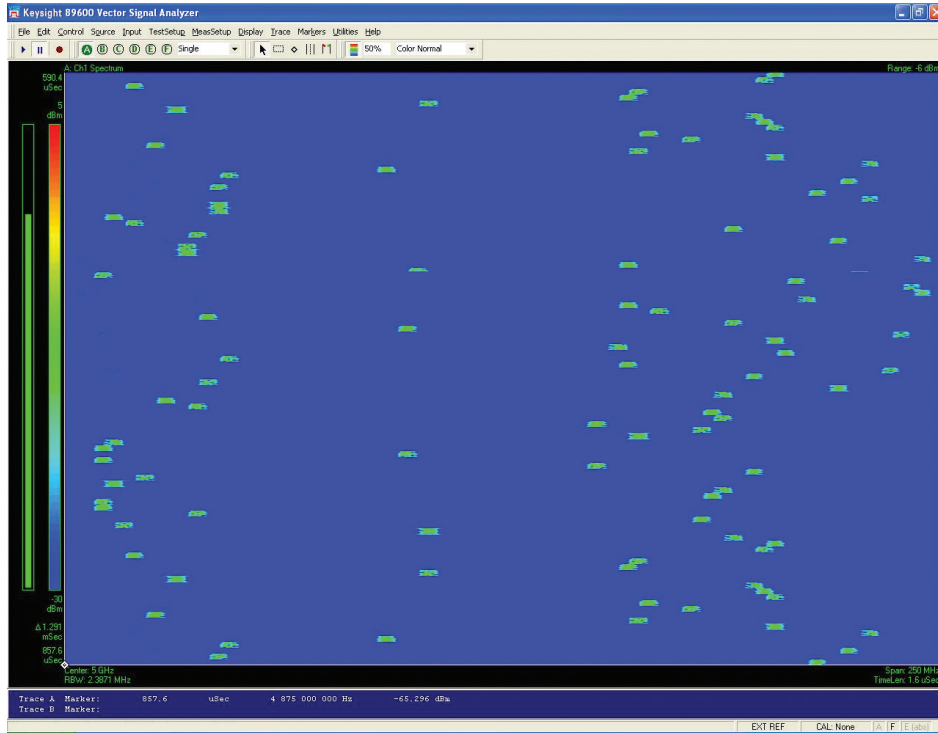

Figure 33. Spectrogram showing frequency agile signal over 1 GHz span, made with 89600 VSA software running on a 90000 series oscilloscope.

Gap-free measurements

Another useful feature of a vector signal analyzer is the ability to perform gap-free analysis. All data within the analysis bandwidth of the instrument—and the associated time record—is being captured and can be analyzed. This can be done via post-processing on captured signals or, with a suitably equipped analyzer, in real time on live signals.

A vector signal analyzer with capabilities such as those provided by the 89600 VSA software performs gap-free analysis by taking advantage of the record-playback feature. A signal captured into memory can be played back and analyzed at the same or a different center frequency and with the same or a narrower bandwidth—without skipping any data. Figure 34 shows a gap-free spectrogram view of a chirped radar signal. The spectrogram shows the linearly changing frequency of the chirp and the pulse widths of the signal. In this example, the FFTs are set to overlap to compensate for the effects of windowing and thereby reveal more detail in the signal's spectral content

N9030AK-RT1 (85 MHz) and RT2 (160 MHz), real-time spectrum analyzer

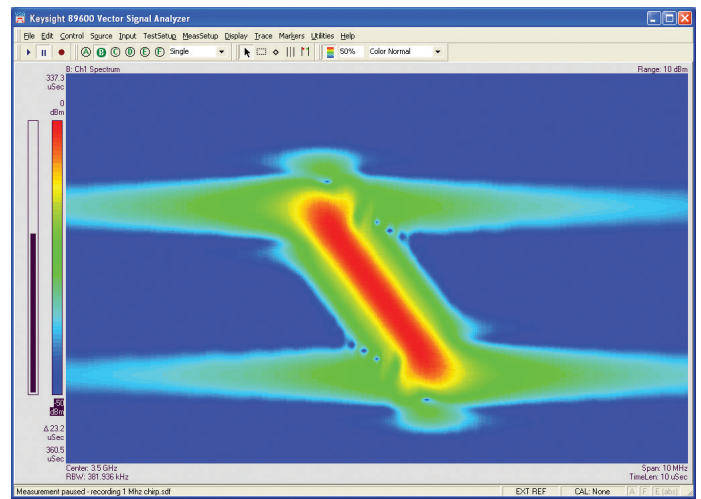
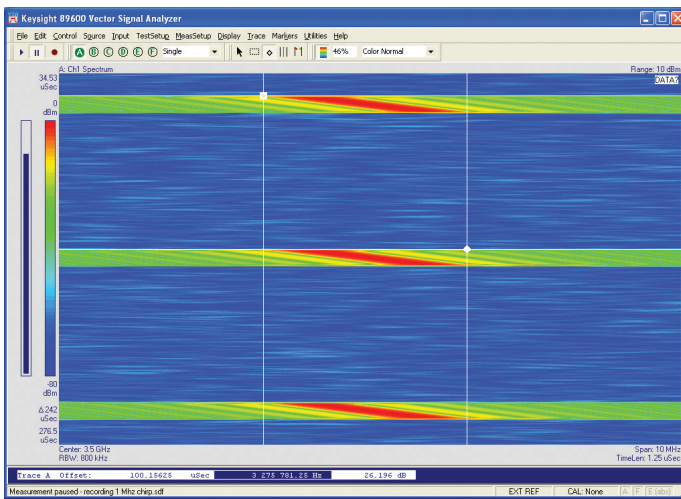
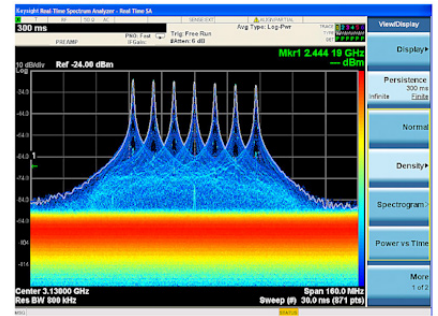

Figure 34. Spectrogram showing chirped radar signal. The left view shows the spectrogram of three consecutive pulses. The right view shows detailed view of a single pulse.

A gap-free real-time measurement is performed on live signals with an analyzer such as an Keysight PXA equipped with the real-time spectrum analyzer (RTSA) option. There are two versions of the RTSA option: one provides a maximum real-time analysis bandwidth of up to 85 MHz (exportable) and the other reaches 160 MHz (non-exportable).

The phrase “real-time analysis” and the capabilities it implies mean different things to different people. Fortunately, though, a consistent core concept can be defined as follows: In a spectrum or signal analyzer with a digital IF section, real-time operation is a state in which all signal samples are processed for some sort of measurement result or triggering operation. In most cases the measurement results are scalar—power or magnitude—corresponding to traditional spectrum measurements. A real-time PXA is compatible with the 89600 VSA software, providing a solution that combines RTSA capabilities with deeper analysis of pulsed, chirped and modulated signals.

The RTSA options provide excellent probability of intercept (POI), analysis bandwidth, sensitivity and frequency range—capabilities that enable system developers and signal analysts to see, capture and understand highly elusive signals.

When configured with RTSA, the PXA signal analyzer can detect intermittent signals with durations as short as 3.57 μ s. To help users detect more signals in less time, a real-time PXA provides 75-dB spurious-free dynamic range across analysis bandwidths of up to 160 MHz and within a measurement range of 50 GHz. It also provides sensitivity of -157 dB at 10 GHz (no preamp).

Power statistics – CCDF

The CCDF measurement is used to measure the statistical power characteristics of a signal. It calculates the peak-to-average ratio (peak-to-average is equivalent to the duty cycle for basic pulses) and plots the power on a graph that shows power in dB above average power on the x axis and percentage of time on the y axis. With the measurement result, the percentage of time the signal is at a specified power level above the average power can be determined. The CCDF measurement is especially useful for determining the power characteristics of shaped pulses or the peak-to-average (duty cycle) of radar signals that vary their PRF.

Figure 35 shows an example of the CCDF measurement for a simple pulse and a shaped pulse. The peak-to-average ratio of the simple pulse is equivalent to the duty cycle. The shaped pulse shows a more gradual transition in power levels.

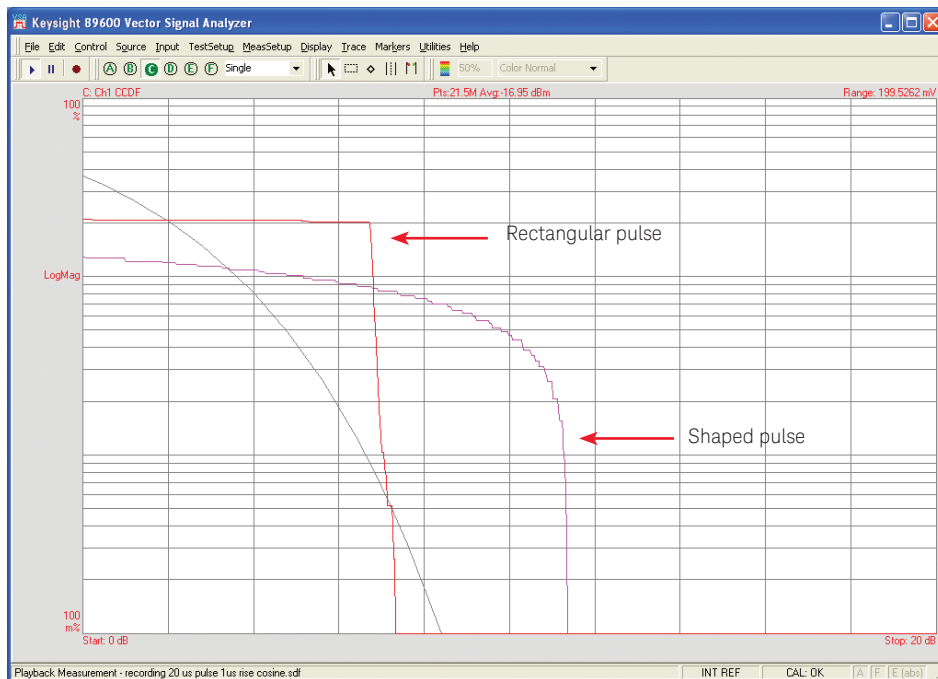

Figure 35. CCDF measurement of a square pulse radar signal compared to a raised-cosine-shaped pulse radar signal. A CCDF plot describes the power statistics of a signal by plotting the percentage of time (y axis) the signal spends at x dB above the average power (x axis).

Chirp linearity

Because the vector signal analyzer is able to analyze both phase and magnitude of a signal, it is a useful tool for measuring modulation on a pulse such as a chirp. A common measurement to make on a chirp radar signal is to examine the phase error. Because phase error is directly proportional to the frequency change, the result is an analysis of the chirp's frequency modulation. An example group delay measurement of a linear chirp is shown in the bottom left corner of Figure 31 on page 45.

Pulse-coded modulation

The ability to view phase as a function of time is a useful feature for analyzing the modulation on a pulse for a coded radar pulse. Typically, this coding is applied to the pulse by modulating the phase. Figure 36 shows an example of a coded-pulse measurement. Notice the 180° phase shift that can be seen in the phase-versus-time display (upper right).

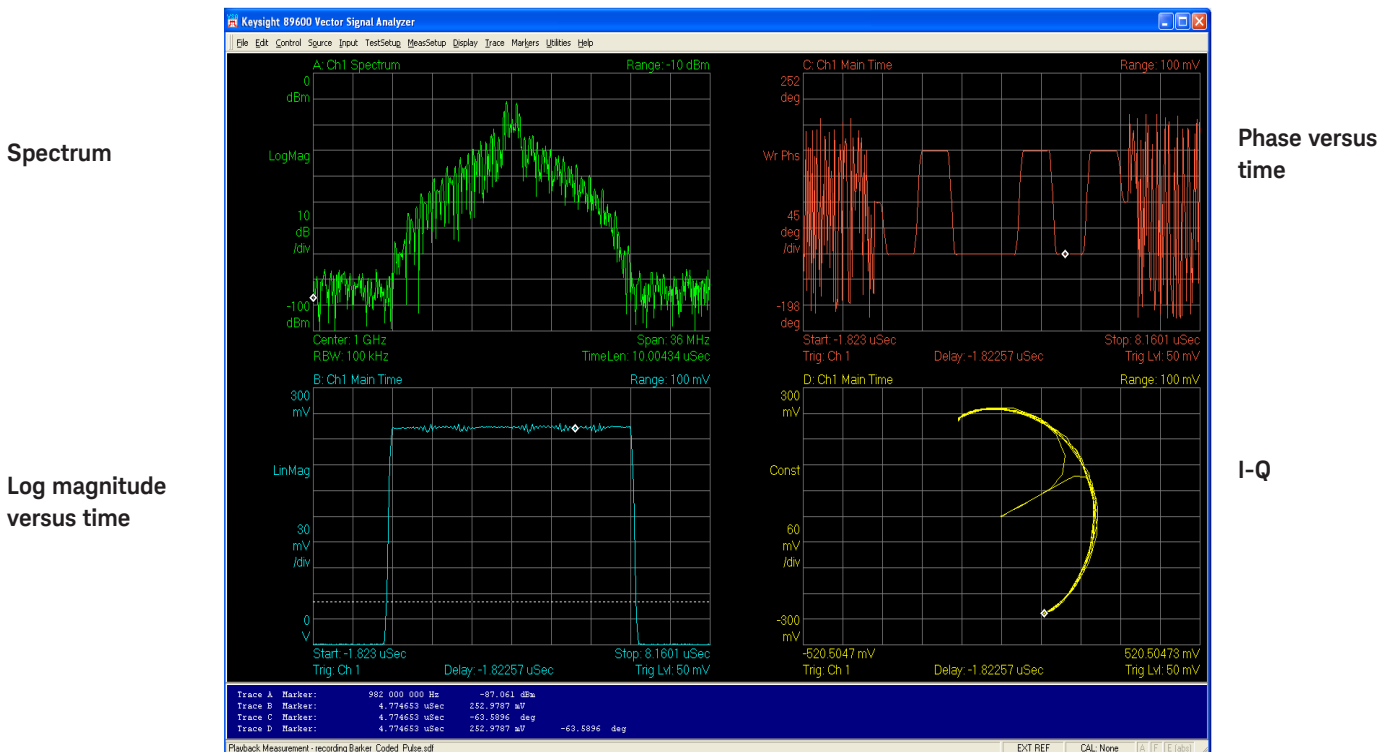

Figure 36. A vector signal analyzer has the ability to examine phase variations over time. This is a useful feature for examining a Barker coded pulse with code embedded in the phase transitions.

Considerations for wideband vector signal analysis

Engineers seeking wideband measurement capabilities at high frequencies generally have very few alternatives. A typical solution uses a block downconverter in front of the digitizer. There are two problems with this approach. For one, converter phase and amplitude linearity must be properly calibrated to ensure meaningful measurements. The other: Most calibrations on block downconverters are difficult and have limited versatility.

The VSA software contains a powerful calibration utility (the “calibration wizard”) that determines the phase and amplitude frequency response of the downconverter and digitizer.¹ The calibration wizard uses an Keysight signal generator as a stimulus signal and can be used to calibrate the wideband IF of the PSA spectrum analyzer (Option 140 or 122 when used for RF frequencies above 3 GHz). It can also be used to provide system-level calibration of a system composed of a PSA spectrum analyzer used as a downconverter, and an oscilloscope.

1. The calibration wizard is a standard part of the 89600 VSA software.

When facing stringent dynamic range requirements, focusing on only the resolution of the digitizer is ill-advised. In the case of demodulation measurements, complete system performance (including phase or amplitude linearity) is more often the limiting factor in measurement performance. In the Keysight solution, combining oscilloscope oversampling with the VSA calibration routine provides a signal-to-noise ratio greater than 65 dB and residual EVM performance of around 2 percent for digital signals with a bandwidth of up to 300 MHz. (To learn more, please see the Keysight product overview, *Wideband Vector Signal Analysis Systems*, publication number 5989-9054EN.)

Time analysis

Enhanced capabilities such as the 89600 VSA software and the N9051A pulse measurement software are convenient tools for many radar and modulation-domain applications. In contrast, today's oscilloscopes offer a variety of general-purpose measurement functions that are also useful for characterization of radar systems. For example, scopes such as the Keysight Q-Series provide sampling rates of up to 160 GSa/s on two channels, bandwidths of up to 63 GHz, and up to 2 Gpts of memory. The input channels are magnitude-flat, phase-linear and phase-coherent. Analysis capabilities include built-in math processing, and these functions can also incorporate MATLAB-based custom programs. This combination of performance and functionality is well-suited to advanced requirements in radar design and debug.

Time-domain analysis with an oscilloscope

Capturing both the envelope information about a radar pulse and the coded information of the radar pulse continues to be a challenge. The high sample rate and deep memory available on Keysight oscilloscopes allows much more of a radar signal to be captured. This is increasingly important as highly sophisticated coding is applied to radar signals.

Many of the capabilities built into today's scopes can also be applied to detailed troubleshooting and analysis of these systems. For example, a radar signal can be directly digitized at RF or IF, then run through the scope's internal math functions, which can find the absolute value, low-pass filter the signal and then apply trending and histograms to the pulses (Figure 37).

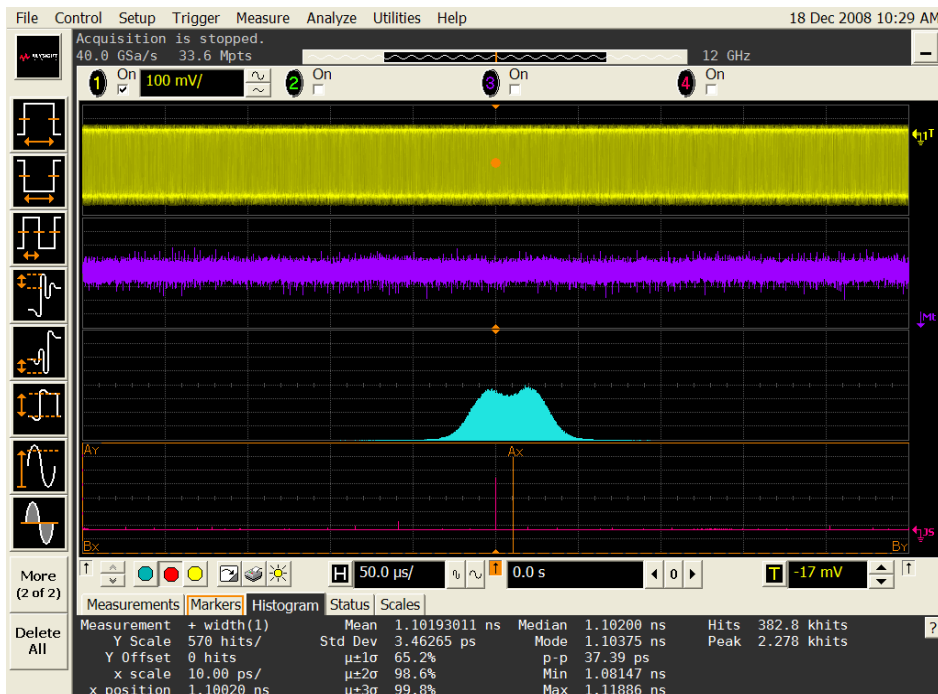

Figure 37. The built-in capabilities of the DSO90000 series make it possible to acquire a chirped radar pulse with a bimodal PRI and then display a histogram of thousands of pulses.

Oscilloscopes such as the Infiniium 90000 X-Series and 90000 Q-Series also have special digitizing modes such as segmented memory, which allows the user to capture long stretches of time-domain signals at very high sample rates. This is accomplished by creating “virtual” segments within the memory that are filled only when a pulse is present (Figure 38). The result is very high-speed digitizing that conserves memory in between pulses with a low duty cycle, and the interval between pulses is “stamped” with the same accuracy as that of the high-speed samplers.

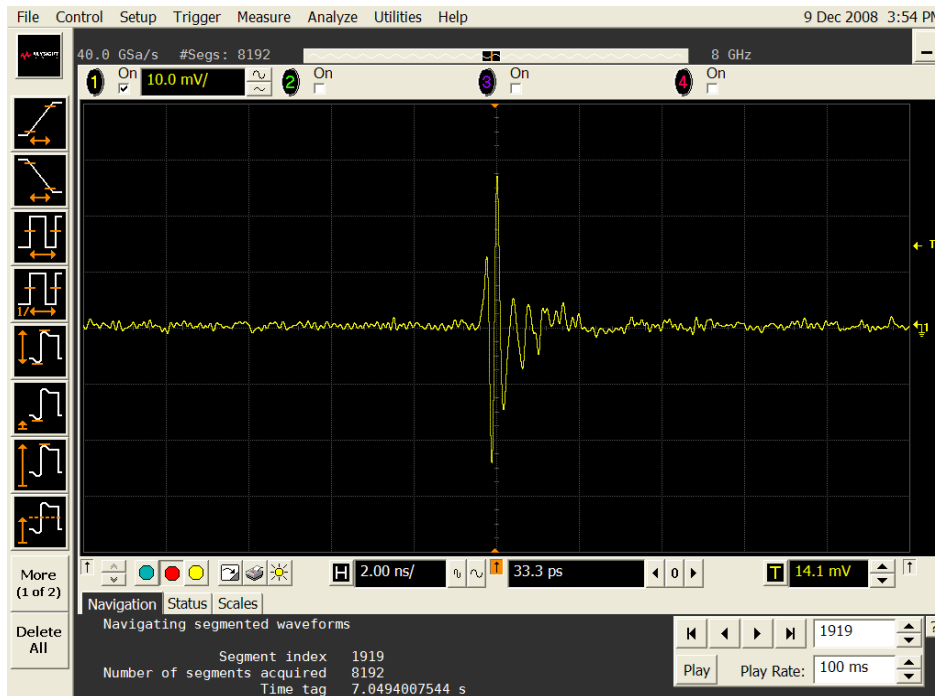
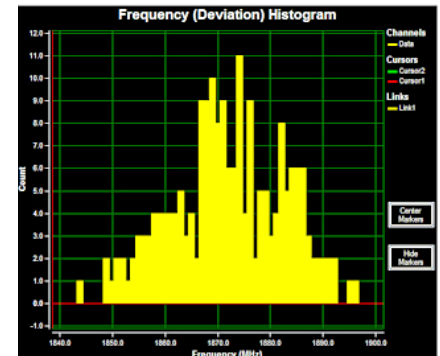

Figure 38. Segment 1919 of 8192 segments occurred at 7.0494007544 sec, sampled at 40 GSa/s.

The multi-channel, phase-coherent nature of the oscilloscope can also be utilized effectively to study multi-channel emitters. For example, with the 89600 VSA software running on an Infiniium oscilloscope, the user can directly access and analyze four phase-coherent channels. It is also possible to link or “chain” multiple oscilloscopes together to achieve as many phase-coherent channels as necessary. In radar systems that have more than 300 MHz of instantaneous bandwidth above 63 GHz, the Keysight N5280A and N5281A test sets provide four channels of phase-coherent frequency conversion. With frequency width of up to 1.5 GHz (N5280A) and frequency range of up to 50 GHz (N5281A), the test sets can downconvert ultrawideband radar signals into the direct digitizing range of Infiniium series oscilloscopes. When system characterization requires time-correlated measurements between the analog and digital domains, a configuration that includes an Keysight mixed-signal oscilloscope (MSO series) provides an easy, efficient solution.

W2650A oscilloscope analyzer Software



The W2650A oscilloscope signal analyzer (OSA) software adds pulse and modulation-domain capabilities to 9000, 90000 and 90000 X-Series oscilloscopes.

- Perform pulse analysis for signals up to 32 GHz carrier frequency with multi-gigahertz analysis bandwidths
- Simplify signal analysis of complex waveforms
- Achieve quick insight into system performance and field test results
- Utilize Infiniium deep memory capture and optimizes usage using segmented memory feature

A similar solution is the N9051A software, which adds pulse measurement capabilities to Keysight X-Series signal analyzers (page 34).

Component and subassembly test

Maximizing radar performance requires thorough analysis and careful optimization of each subassembly and component in the radar system.

The effects of signal losses caused by system components in the transmit path are directly characterized by the L_t and L_r terms in the radar range equation (page 11). Power can be expensive and losses directly reduce the effective power of the radar: A 1 dB loss has the same impact as a 1 dB reduction in power. When transmitting 1 MW of power, a 1 dB increase to accommodate for a loss can be expensive. The more losses can be minimized, the better. Loss measurements are especially important for components such as filters, duplexers, and circulators that are located after the transmit power amplifier and before the low-noise amplifier of the receiver.

Though not shown directly in the radar range equation, component phase and amplitude flatness and group delay also affect radar performance. These impairments have an indirect impact on the range by limiting the radar's ability to optimally compress the signal with a matched filter. In addition, these impairments may limit the radar's ability to extract information such as Doppler shifts from radar returns.

A common way to characterize component effects including loss, flatness and group delay is utilizing S-parameter measurements. S-parameters describe the incident and reflected response of a component in complex terms and paint a comprehensive picture of the linear effects that the component is having on the signal. These measurements are typically made with a network analyzer using a CW stimulus.

With radar, however, it is often not sufficient to make measurements in a conventional way using continuous wave signals. There are at least two reasons for this. One is that the performance of components may differ when tested under pulsed conditions versus a CW stimulus due to different bias conditions, ringing effects caused by fast rising edges, or different operating temperatures. Another possible reason is the fact that a device may not be designed to handle the power dissipation associated with a continuous stimulus.

In the remainder of this section, the various approaches to measuring components and subassemblies will be presented.

Direct measurement of power loss with a power meter

A simple way to measure losses is to use a power meter. Power meters such as the Keysight P-Series, EPM-P, or EPM Series offer dual-port models (optional) to allow simultaneous measurements (as long as measurement ports are available before and after the element being tested). By making a measurement before and after the device, the power difference can be determined.

The accuracy of measuring losses with a power meter is typically less than what can be achieved with a calibrated vector network analyzer; however, the advantage is that the measurement can be made under normal operating conditions.

This may be important for measuring in the transmit path because power levels may be much higher than can be provided by a signal generator or network analyzer used in a stimulus/response test setup. Another point that should be noted is that the measurement results from a power meter may not directly correlate with the results from instruments such as network analyzers because power meters are broadband detectors that measure fundamental and harmonic power as opposed to the tuned-receiver measurements of a network analyzer, which isolates the fundamental signal component.

Measuring with a network analyzer

Network analyzer measurement modes

Before discussing the specific measurements made with a network analyzer, it is necessary to first discuss the different modes of measuring pulsed RF signals.

Network analyzers can measure pulsed RF signals using either a wideband (or synchronous acquisition) detection mode or a narrowband (asynchronous acquisition) detection mode. A summary of these modes is given here. (A more detailed discussion can be found in Keysight Application Note 1408-12, Pulsed-RF S-Parameter Measurements Using Wideband and Narrowband Detection, literature number 5989-4839EN.) [7]

Wideband detection mode

Wideband detection can be used when the majority of the pulsed-RF spectrum is within the bandwidth of the receiver. It can be thought of as being analogous to the zero-span mode of a spectrum analyzer, as shown in Figure 39. In this case, the pulsed-RF signal will be demodulated in the instrument, producing baseband pulses, again similar to zero span in the spectrum analyzer. This detection can be accomplished with analog circuitry or with digital signal processing (DSP) techniques. With wideband detection, the analyzer is synchronized with the pulse stream, and data acquisition occurs only when the pulse is in the on state. This means that a pulse trigger synchronized to the PRF must be present. For this reason, this technique is also called synchronous acquisition mode.

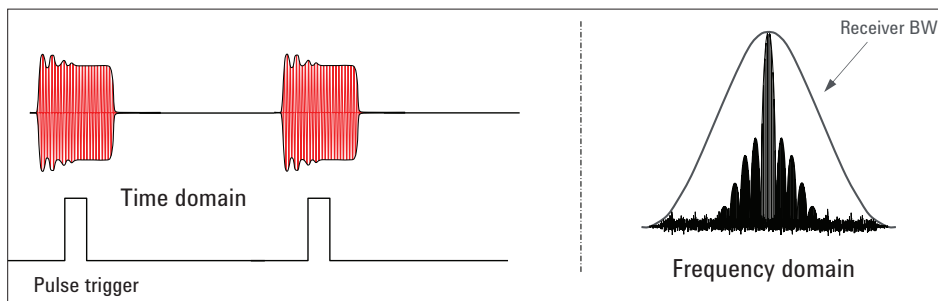
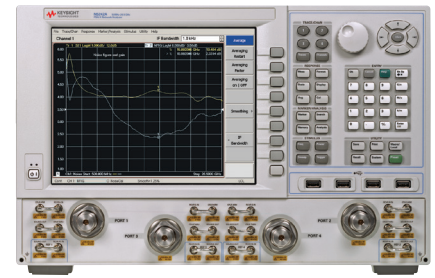

Figure 39. Wideband detection mode (synchronous detection mode) of a network analyzer requires the majority of the pulse power be contained within the receive bandwidth of the network analyzer. Wideband mode may have the best dynamic range for signals with low duty cycle but will be limited in measurable pulse widths due to bandwidth constraints.

PNA-X network analyzer



Fast, accurate passive and active device characterization

- Pulsed S-parameter test
- Single connection active device test including noise figure
- Error-corrected frequency converter test
- 2-, 4- & N-port configurations
- Single-ended and balanced measurements with true balanced stimulus
- Simplified calibration with ECal module
- High-accuracy noise figure measurements using a unique source-correction technique

The advantage of the wideband mode is that there is no loss in dynamic range when the pulses have a low duty cycle (long time between pulses). The measurement might take longer, but because the analyzer is always sampling when the pulse is on, the S/N ratio is essentially constant versus duty cycle. The disadvantage of this technique is that there is a lower limit to measurable pulse widths. As the pulse width gets smaller, the spectral energy spreads out – and once enough of the energy is outside the bandwidth of the receiver, the instrument cannot properly detect the pulses. Viewed in the time domain, when the pulses are shorter than the rise time of the receiver, they cannot be detected. In the case of the Keysight PNA-X network analyzer, the bandwidth limit is 5 MHz, which corresponds to a minimum pulse width of approximately 250 ns.

Narrowband detection mode

In narrowband detection mode the receiver bandwidth of the network analyzer is set to filter out all of the signal power out except the central spectral component, as shown in Figure 40. Narrowband detection mode is analogous to the line-spectrum mode of a spectrum analyzer except the analyzer stays tuned to a specific frequency. The center spectral component of the signal represents the frequency of the RF carrier. After filtering, the pulsed RF signal appears as a sinusoidal or CW signal. With narrowband detection, the analyzer samples are not synchronized with the incoming pulses (so no pulse trigger is required), thus the technique is also called asynchronous acquisition mode.

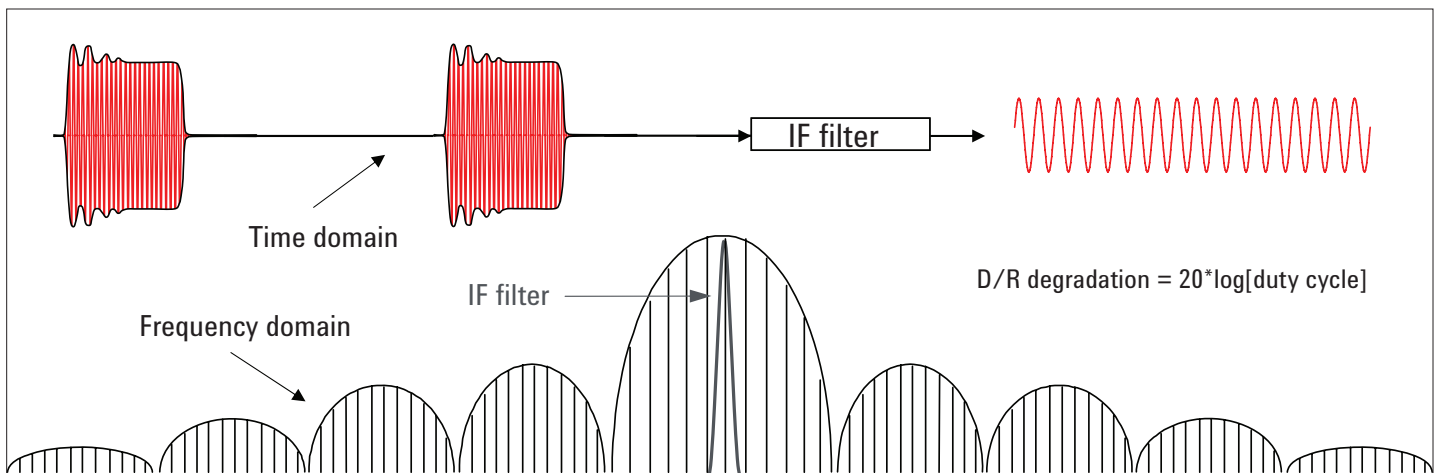

Figure 40. The narrowband detection mode (asynchronous detection mode) of a network analyzer uses a narrow filter to extract only the central spectral component. The narrowband mode has no pulse width limitations.

Keysight has developed a novel way to achieve narrowband detection using wider IF bandwidths than normal and a unique spectral-nulling technique. This technique lets the user trade dynamic range for speed, with the result almost always yielding faster measurements than those obtained without the technique.

The advantage to narrowband detection is that there is no lower pulse-width limit because, no matter how broad the pulse spectrum may be, most of it is filtered away, leaving only the central spectral component. The disadvantage to narrowband detection is that measurement dynamic range is a function of duty cycle. As the pulse duty cycle gets smaller (longer time between pulses), the average power of the pulses gets smaller, resulting in less S/N ratio. In this way, measurement dynamic range decreases as duty cycle decreases. This phenomenon is often called pulse desensitization. The degradation in dynamic range (in dB) can be expressed as $20 \cdot \log(\text{duty cycle})$. Some of this degradation can be overcome with sophisticated signal processing. As an example, the PNA-X has a 40 dB improvement in dynamic range compared to a PNA when using a stimulus with a 0.001 percent duty cycle.

Network analyzer measurements

A network analyzer offers a variety of measurements and display functions that can describe the behavior of a component or subassembly. These include insertion loss, group delay, S-parameters, X-parameters and variations of these parameters over time. Figure 41 shows an example of an insertion-loss measurement made in both the narrowband and wideband detection modes of the PNA-X network analyzer. For a pulsed RF signal with pulse width of 1 μs and PRI of 100 μs , the wideband detection mode makes the measurement 17 times faster. Because of the speed advantage the wideband mode is generally preferred when possible. However, as previously explained, the narrowband mode may be the only measurement option for narrow pulses with wide bandwidth.

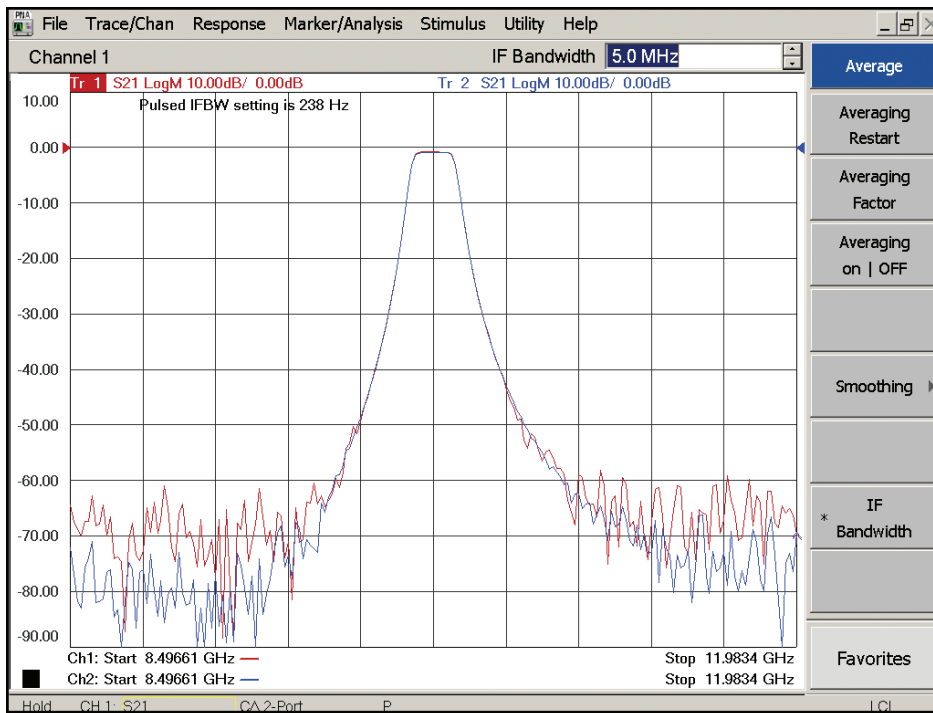

Figure 41. This display shows a comparison of a pulsed insertion loss filter measurement using the wideband mode versus the narrowband mode in the PNA-X network analyzer. In this example, the narrowband mode achieves the best dynamic range; however, which mode is best will depend on the duty cycle.

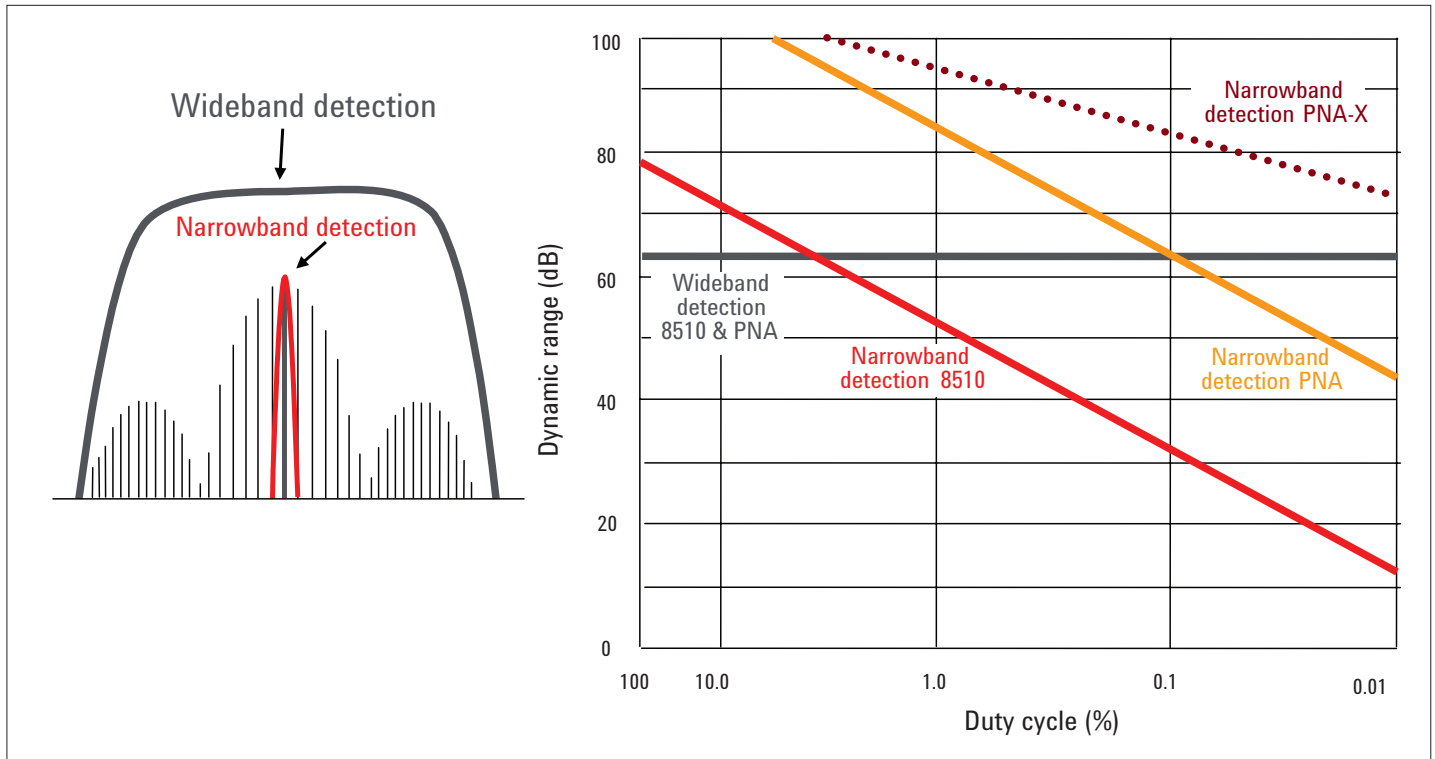

Figure 42. The effects of duty cycle on dynamic range are shown by comparing network analyzer wideband detection and narrowband detection modes

In terms of dynamic range, the advantage depends on the instrument and will be a function of the duty cycle. As can be seen from Figure 42, the PNA-X has exceptional dynamic range performance for the narrowband mode based on the advanced processing techniques it employs.

Network analyzer pulse-response measurement types

Another consideration when making network analyzer measurements is to determine the type of measurement to be made. Detail about how each type is implemented can be found in Keysight Application Note 1408-12, *Pulsed-RF S-Parameter Measurements Using Wideband and Narrowband Detection*, literature number 5989-4839EN. [7]

Average-pulse measurements

Average-pulse measurements are performed by not applying any receiver triggering or gating. This means that the receiver measures and integrates all of the energy from the device-under-test (DUT) during the pulse duration. In effect, when using narrowband mode, the gate widths are set equal to or greater than the pulse width, as shown in Figure 40. Using this method, the average insertion loss or group delay result over the duration of the RF pulse can be plotted against frequency.

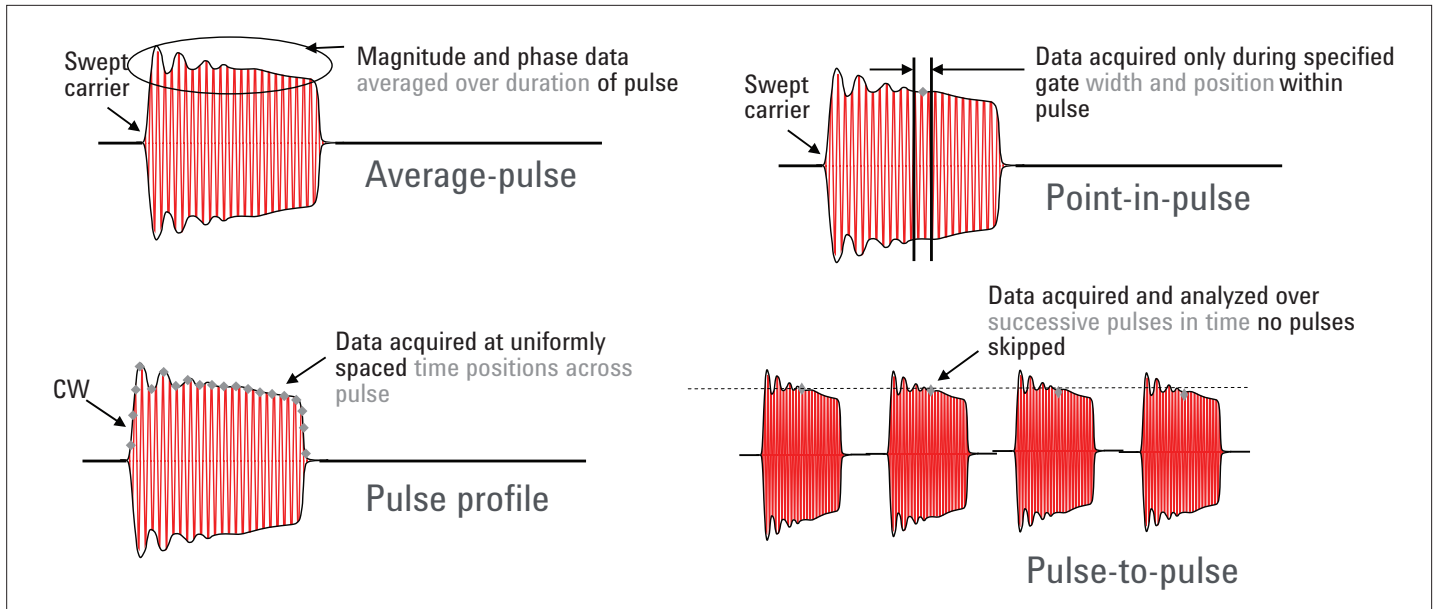

Figure 43. For radar applications, the Keysight PNA has four different pulse-sampling options

Point-in-pulse measurements

Point-in-pulse measurements provide the ability to measure the output of the DUT at any point in time during the pulse by applying a time delay between when the source/bias is pulsed and when the receivers start taking data, as shown in the upper right of Figure 43. A time gate width during which the pulsed energy is allowed to pass to the receivers can also be specified, providing a variable receiver integration window. Using this method, the insertion loss or group delay result for the given time period within the RF pulse can be plotted versus frequency.

Pulse profile measurements

Pulse-profiling is similar to point-in-pulse except that the measurement information is displayed in the time domain (at a CW frequency), where the time axis represents a point-in-pulse measurement with variable time delay (i.e., from a starting delay to a stop delay). This can be thought of as walking the point-in-pulse measurement across the width of the pulse. With the microwave PNA the minimum receiver gate width is approximately 20 ns, resulting in excellent resolution for pulse-profiling analysis, as shown in the lower-left example of Figure 40. The results of a pulse-profile measurement are displayed as function of time rather than frequency. A pulse profile can be used to analyze phenomena such as pulse droop that may be caused by a component.

Pulse-to-pulse measurements

Pulse-to-pulse measurements are used to characterize how a pulse stream changes versus time due to variations in the performance of the DUT. For example, thermal effects in an amplifier can cause gain reduction and phase shifts. The measurement results are displayed as either magnitude or phase versus time with each data point representing a consecutive pulse. The measurement point remains fixed in time with respect to a pulse trigger. The lower-right example in Figure 40 shows a representation of a pulse stream decreasing in magnitude due to gain reduction in a high-power amplifier as it heats up. The pulses do not necessarily need to be repetitive as long as an appropriate pulse trigger is available. For example, the measurement can be made with a diversified PRI. However, a pulse-to-pulse measurement is available only in wideband mode.

Antenna measurements

Antenna performance is critical to every radar system. The antenna gain is a key variable in the radar range equation and therefore directly influences the range.

Antenna gain is defined as the maximum power relative to the power from an isotropic antenna. It is sometimes referred to as directivity. Gain is usually defined in logarithmic terms, dBi (dB relative to an isotropic antenna) and is expressed by the following equation:

$$G_{\text{dBi}} = 4\pi\eta A/\lambda^2$$

Where

η = antenna efficiency

A = antenna area

λ = carrier wavelength

In addition to gain, the polarization of the antennas is also an important consideration. The polarization of the transmit and receive antennas must match each other in order to efficiently transfer a signal. Types of polarization include elliptical (most common), linear or vertical, and circular.

The radar antenna is designed to form a steerable beam. The beam is not perfect and will have a width that is defined as the angle between the 3 dB points, as shown in Figure 44. The width is not necessarily the same in both the horizontal and vertical directions. For example, a tracking antenna may have a pencil beam that is the same both horizontally and vertically. However, a search antenna may have a beam that is narrow in the horizontal axis, but more fan-like in the vertical direction. It is important to consider beam width along with antenna gain because the two are linked: As the beam is narrowed, the gain increases because power is more focused.

Power Density

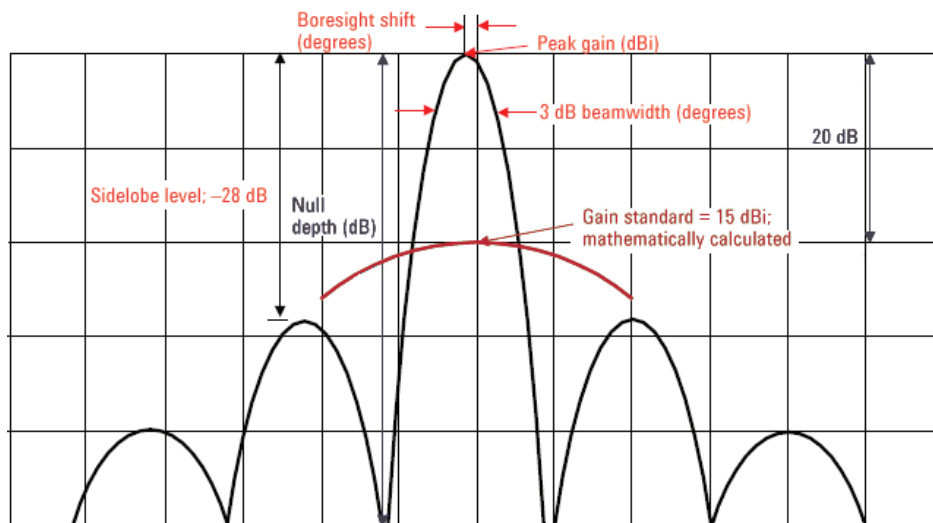

Figure 44. Many importance characteristics of the antenna can be determined from the antenna pattern.

Conventional radar relies on mechanical positioners to steer the beam. Modern radar may use electronically controlled antenna arrays, which can greatly increase the speed and accuracy of beam steering. A boresight measurement (intended angle versus actual measured angle of the peak power) helps calibrate the direction of the beam. The accuracy in steering the antenna will determine the accuracy with which the direction of the target can be identified.

Sidelobes are undesirable artifacts of beam forming that transmit energy in unwanted directions, as shown in Figure 44. Sidelobes are generally small but can be measured against their theoretical limits for a given antenna design. It is desirable that the sidelobes be small to avoid false returns due to objects near the antenna.

In addition to gain, polarization, beam width, boresight, and sidelobes, other common antenna measurements include frequency response and impedance.

Far-field versus near-field antenna test

Two common configurations are typically used to test antennas, far field and near field, as shown in Figure 45. Each has advantages and disadvantages.

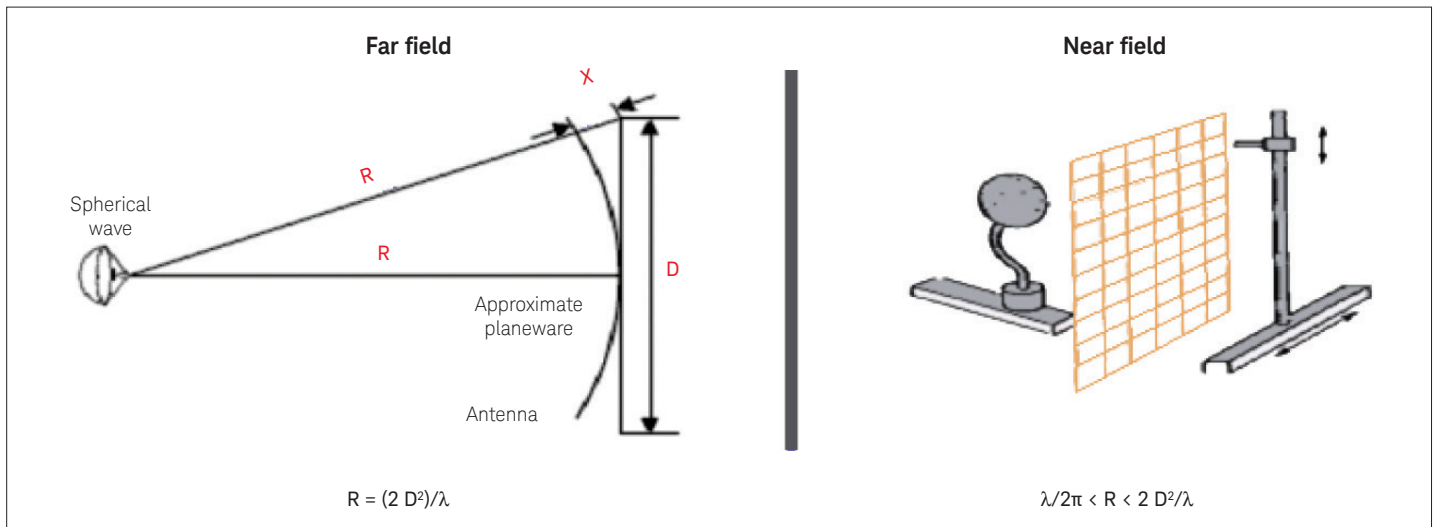

Figure 45. Antenna measurements can be made using either a far-field or near-field approach. Far-field testing is simpler and faster but requires a large area. Near-field testing requires sophisticated calculations and may take longer to perform, but requires less space.

Far-field antennas usually operate with a long distance between the source and receive antennas. Antennas radiate a spherical wavefront but at great distances the spherical wavefront becomes almost planar across the aperture of the receive antenna. Antennas must be separated to simulate a planar wavefront to reduce receiving errors. The generally accepted far-field criteria is $R > 2D^2/\lambda$, which allows 22.5 degrees of phase variation across the aperture of the antenna-under-test (AUT).

Near-field antennas usually operate at much shorter distances between the source and receiving antennas. Very near the antenna plane, the field is reactive in nature and falls off more rapidly than the radiating near-field region. Near-field measurements are made in the radiating near-field region of $\lambda/2\pi < R < 2 D^2/\lambda$. Near-field measurements involve large amounts of data collection and transformation analysis to derive the far-field result.

Far-field test configuration

Far-field test configuration footprints generally run from 10 to 1,000 meters and are the primary drawback of far-field test setups. The advantage is that the testing requires less calculation and can be faster.

With a far-field antenna measurement, the radiated energy is measured in real-time as the AUT is rotated in azimuth and elevation coordinates. The resulting data is a measure of amplitude, phase or both as a function of angular position. The rotation of the antenna is usually accomplished with a mechanical positioner, which determines the exact position in the coordinate system and typically restricts movement to a single axis at a time.

An example far-field test configuration using the Keysight PNA is shown in Figure 46. The configuration utilizes 85320A/B external mixers and an 85309A LO/IF distribution unit to provide the first downconversion so that the mixers can be located near the antennas. The first downconversion is to an IF frequency of 8.333 MHz, which is the second IF frequency of the PNA.

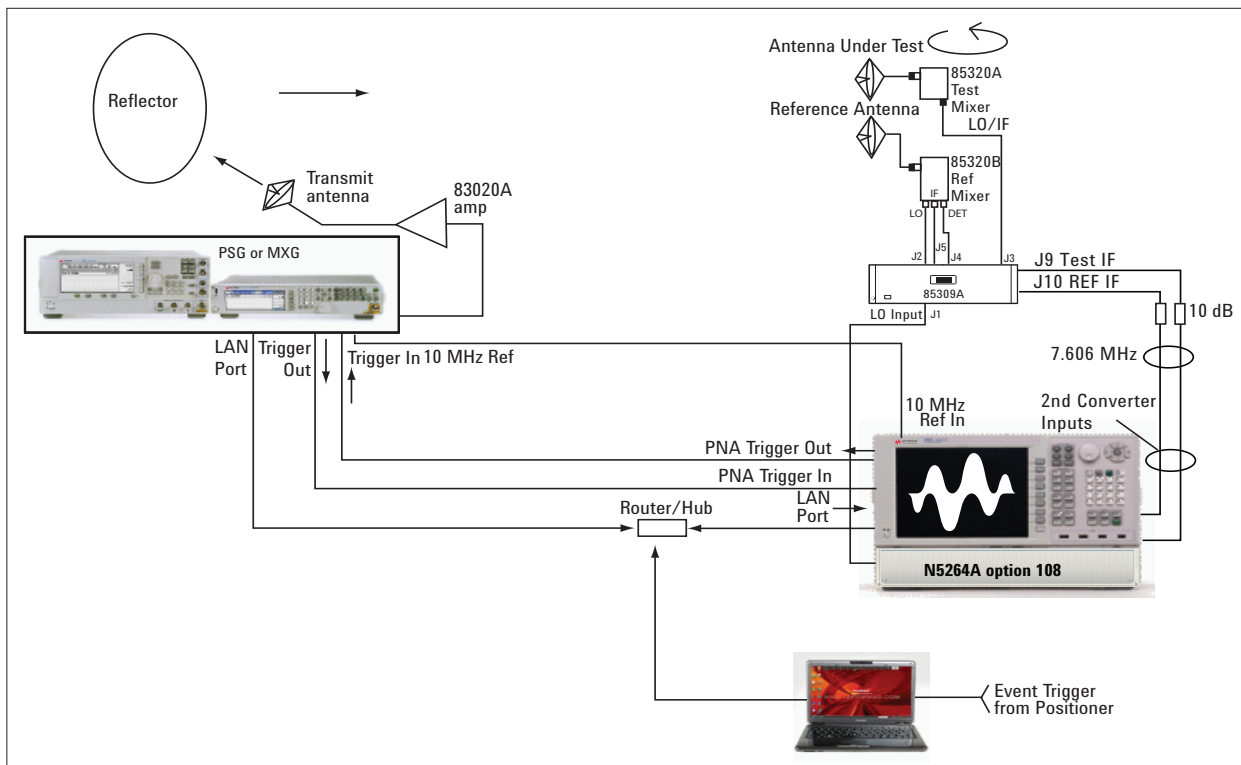

Figure 46. In this example of a far-field antenna test configuration, external mixers are used so that they can be placed close to the reference and test antenna. Directly inputting the IF signal into the PNA second mixing stage also improves measurement sensitivity.

An important aspect of maximizing the receiver sensitivity is to minimize losses to the signal under test. To help with this the PNA-X provides a way to bypass the PNA coupler and first IF converter stage (Option H11). Doing this improves sensitivity by as much as 20 dB.

For a larger far-field antenna range, controlling a remote microwave source across a significant distance is always a concern. This configuration in Figure 43 uses a PSG microwave signal generator (source), and utilizes TTL handshake triggers between the PNA/PNA-X and the PSG source. Low-cost fiber optic transducers are one approach that could be used to provide long-distance TTL transmission signals across a far-field antenna range.

Figure 47 shows another example test configuration that can be used for smaller far-field ranges. This simpler configuration can be used when the range is small enough to ensure that cable losses will not affect the measurement. Optionally, optical extenders can be used for larger ranges. They will have a modest impact on output power, but will not influence test throughput.

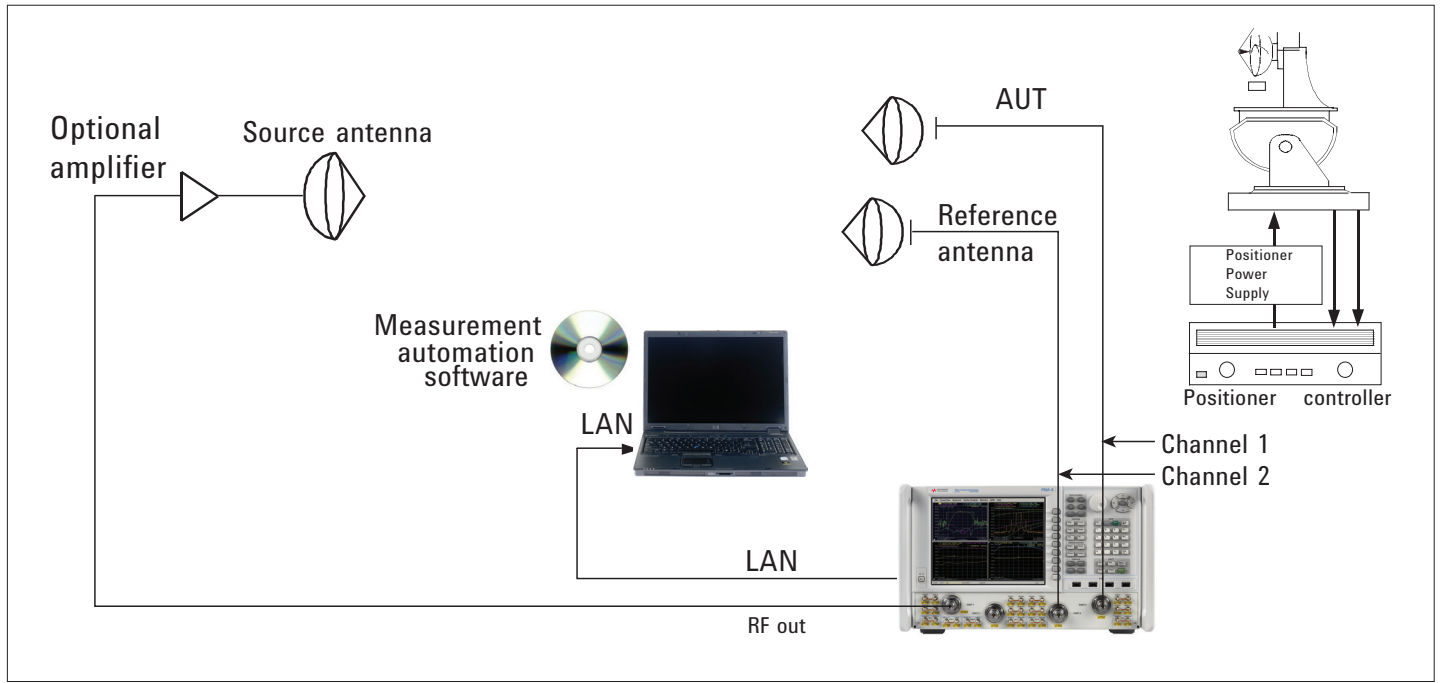

Figure 47. This example of a simple test configuration with a network analyzer is used for smaller far-field test setups, but may not be possible for large ranges due to cable losses.

There are several advantages to using a small-range configuration versus a large-range configuration. With a small-range configuration, the network analyzer helps minimize cost, space and complexity by providing the source and the required receiving channels. Significant speed and cost improvements can generally be accomplished with this configuration. Additionally, the PNA/PNA-X network analyzer can measure up to four independent inputs simultaneously, providing a highly integrated, cost-effective solution.

Once the test process is established, the process for analyzing the antenna pattern involves making many gain and phase measurements relative to the known reference antenna while varying the angular position of the antenna. This can be a laborious process and therefore is typically done with antenna measurement software that can control the position of the antenna and synchronize the measurements with the network analyzer and reference source.

Near-field test configuration

Near-field methods measure the far-field patterns of an antenna by means of a different technique. A near-field method moves a probe across the aperture of the antenna and measures amplitude and phase points on a sample grid spaced every half wavelength, as shown in Figure 48. Depending on the nature of the antenna, different scan patterns can be used. The energy radiated in the near-field region is analytically converted to the far-field result using a Fourier transform computational technique that produces standard far-field antenna patterns.

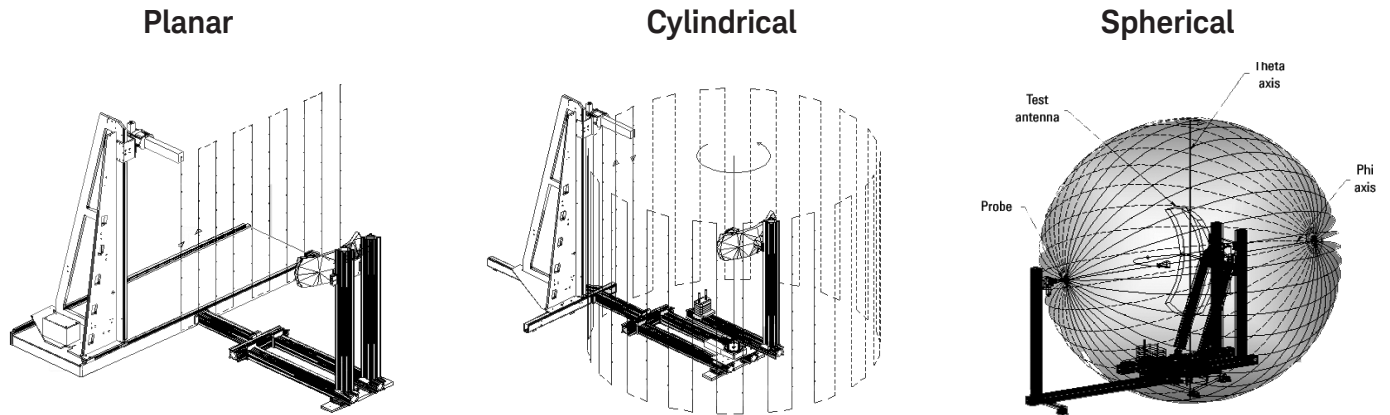

Figure 48. A near-field test uses different scan patterns depending on the type and purpose of the antenna.

Near-field antenna ranges have many advantages over far-field ranges: less space is required; the antenna is protected from weather; there is better security for the antenna and test frequencies; and, for very large antennas, a near-field system is usually significantly lower in cost. The main disadvantage is the complexity and time required to measure and process large amounts of data.

Figure 49 illustrates a basic near-field antenna measurement configuration utilizing a PNA family network analyzer. It is similar to the small-range configuration. The network analyzer operates both as the source and the receiver, while an external software application controls the data collection, the timing of the network analyzer and the movement of the positioner. Additionally, the external application controls the switching of the AUT polarization.

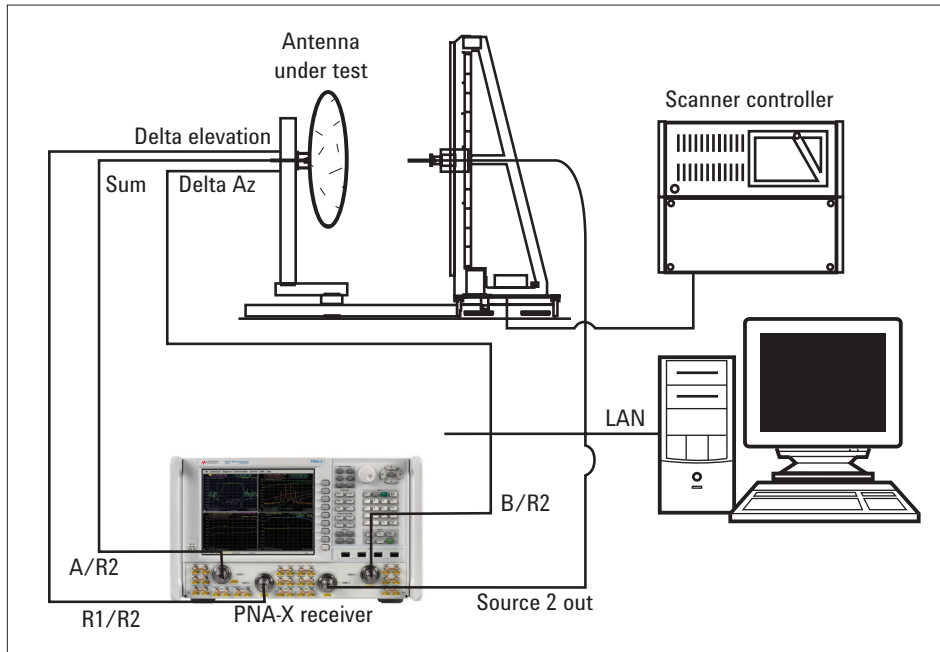

Figure 49. This is an example of a near-field antenna test configuration. Far-field antenna pattern results are extrapolated from the near-field measurements using transformational analysis.

To minimize the test time, the frequency can be multiplexed during each data scan. However, this can result in a misalignment of the rectangular near-field grid between forward and reverse data scan directions, producing errors in the far-field pattern result. These errors can be eliminated by always collecting data measurements in the same scan direction; however, this doubles the test time. Alternatively, the frequencies can be scanned in reverse order on the reverse scan. Using this reverse sweep in conjunction with correct triggering between the forward and reverse passes ensures that each frequency set is spatially aligned on the rectangular near-field grid. This technique requires an RF source that supports a “reverse frequency list” mode of operation. The PNA/PNA-X network analyzer includes reverse sweep and edge triggering capabilities specifically designed for antenna measurements.

Example antenna measurement results

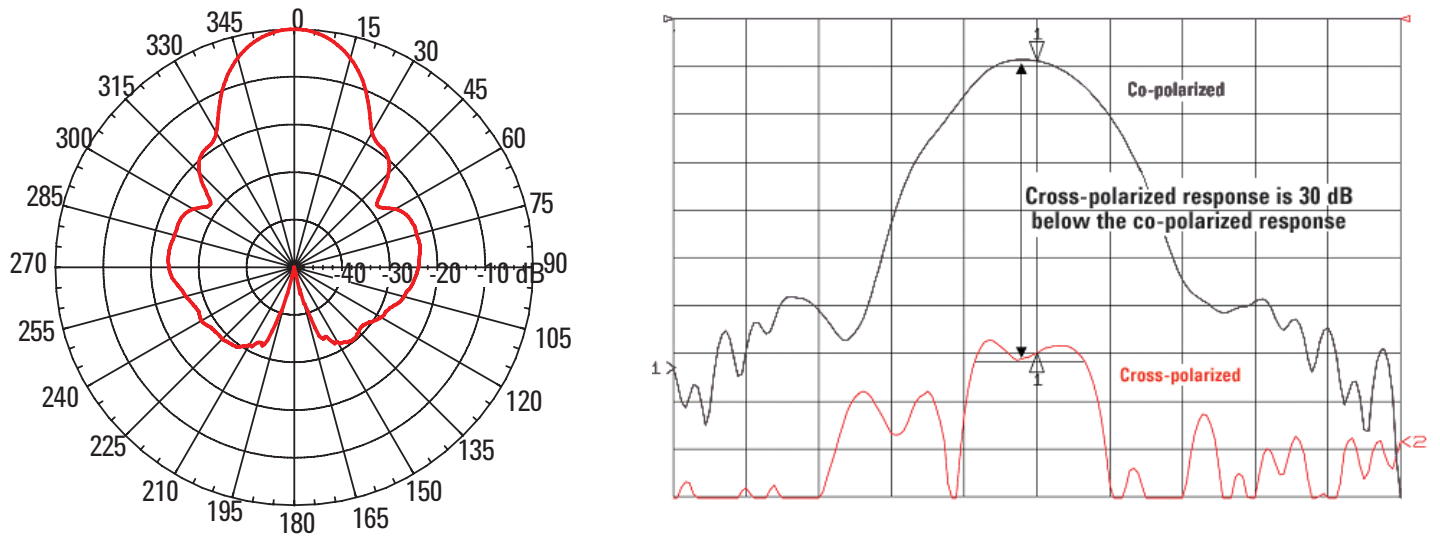

Figure 50. Examples of a far-field antenna pattern and a cross-polarization measurement. The gain can be measured and compared using different polarization orientations of the antenna.

The left-side image in Figure 50 is an example of a far-field antenna pattern for an X-band radar in the horizontal plane. Measurement results from the principle planes are often used to characterize antenna performance. The results could be obtained using either near- or far-field techniques. A number of antenna characteristics can be read from the results: gain, beam width, sidelobe level and more.

Another example of an antenna pattern measuring the cross polarization is shown in the right-side image of Figure 50. The cross polarization is essentially the difference in the result with opposite polarization. In this case a difference of 30 dB is observed, which is a good level of polarization purity. A well-designed linear antenna should respond to only the polarization for which it was designed.

Solution for multi-aperture and phased-array antennas

A multi-aperture or phased-array antenna consists of multiple antennas or radiating elements that form a beam of specific shape or direction by manipulating the relative phase of each transmitted signal. Combining the elements of an array antenna with beamforming techniques enhances spatial selectivity and interference avoidance.

The calibration and testing of these antennas can be quite challenging. As the number of array elements increases, so does the time required to fully characterize the antenna. Thus, the ability to use multiple coherent measurement channels is an effective way to accelerate the testing of a phased-array antenna that includes many elements.

The element-to-element phase and magnitude (gain) errors due to the various components in the array can severely limit overall performance. Because phase is used to steer the beam, the errors introduced by any misalignment of the radiating elements must be calibrated out to ensure efficient and accurate operation.

Depending on the signal type, there are two ways to analyze the cross-channel response: a narrowband swept approach and a wideband-stimulus/wideband-receiver approach. The narrowband method uses a swept or stepped tone and a narrowband receiver to measure one frequency at a time; and it then performs cross-channel computations in the time domain. The other approach is much faster: it uses a wideband stimulus and a wideband receiver to measure all frequencies simultaneously and compute the cross-channel spectra.

The ideal measurement solution has the versatility to use either method, and a wideband digitizer with digital downconversion (DDC) provides the needed flexibility. As part of the digitizer, a hardware-based DDC makes it possible to isolate the signal of interest (SOI) and then improve the SNR and dynamic range within the bandwidth of the SOI by reducing the amount of integrated noise in the time domain. In addition, the DDC reduces the amount of data to be acquired and transferred for a given measurement duration—and this means less work for any post-processing algorithms.

Figure 51 shows a generic block diagram of an eight-channel system that can be used for the testing and calibration of array antennas. The signal path proceeds from left to right, originating with the antenna array under test. Incoming signals are attenuated and downconverted with the goal of translating RF or microwave signals down to an amplitude that matches the full-scale input range and an intermediate frequency that is within the bandwidth of the digitizer.

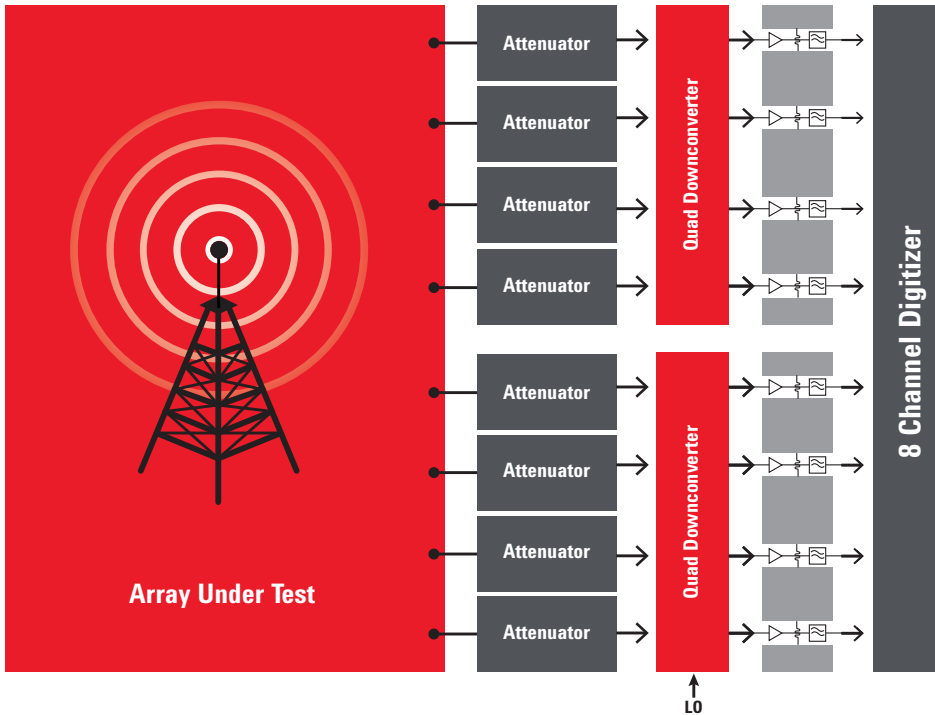
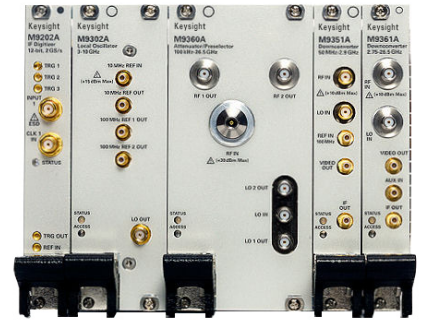

Figure 51. This generic configuration enables rapid phase-coherent test and calibration of multi-antenna arrays.

A multi-channel digitizer with phase-coherent inputs (e.g., less than 1 degree phase difference) makes it possible to test multiple transmit/receive module (TRM) pairs in parallel. In addition, the digitizer must also prove sufficient 3-dB bandwidth to enable characterization of signals across the different functions possible in a phased-array antenna: continuous wave (CW) techniques, wideband techniques, complex modulation, and more.

An example solution is the Keysight M9703A AXIe high-speed digitizer with optional DDC. The M9703A provides eight synchronous acquisition channels with 12-bit resolution and the ability to capture signals from DC to 2 GHz at 1.6 GSa/s (or 3.2 GSa/s with interleaving) into 4 GB of memory. As technology evolves to enable arrays with greater densities, this type of scalable measurement platform can accommodate more digitizer channels and thereby provide a future-ready solution.

M9392A PXI vector signal analyzer



When combined with the 89600 VSA software, the M9392A becomes a complete solution that enables microwave measurements and vector signal analysis in radar, avionics and communications applications.

- Frequency range: 50 MHz to 26.5 GHz
- Up to 250 MHz analysis bandwidth
- Up to 100 MHz streamed analog bandwidth
- Digitizing at 2 GSa/s
- Reduced development time through included drivers, soft front panels and program ming examples

Radar cross section

The radar cross section (RCS) of a target is a measure of its reflectivity in a given direction. There are three main contributors to RCS:

- Specular scattering: Localized scattering dependent on the surface material/texture
- Diffraction scattering: Incident signal scattering at target edges and discontinuities
- Multiple bounce: Reflections among target elements at offset angles

As shown by the radar range equation on page 6, the radar cross section (σ) has a direct effect on the range of the radar. Although the radar designer cannot control the cross section of the target, the objective in modeling RCS is to develop simulation tools capable of predicting the behavior of radar receivers in a realistic environment.

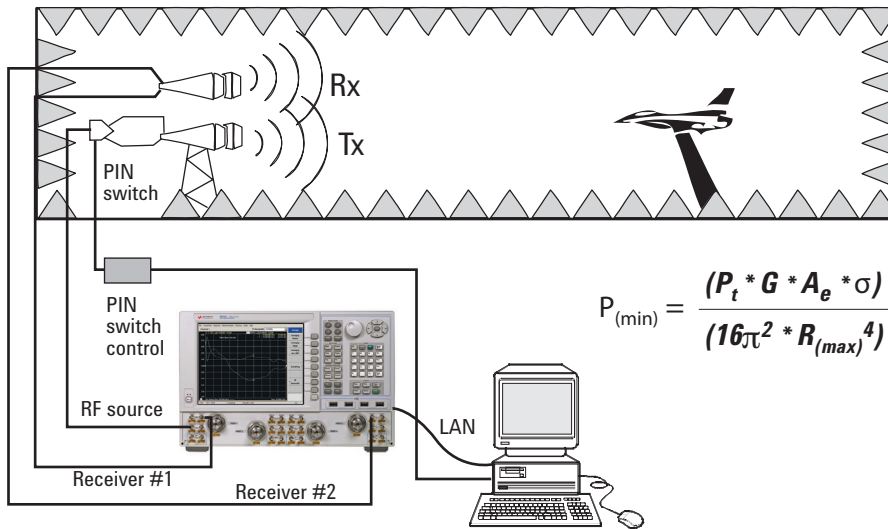

Figure 52. This example radar cross section measurement setup uses a network analyzer and an anechoic chamber.

Figure 52 shows a basic range setup for transmission and reception of co-polarized and cross-polarized signals. In this configuration, the network analyzer measures both polarizations simultaneously through independent measurement channels while also providing the source signal to the transmitting antenna.

Improvements in technology have enabled a greater understanding of how to minimize the reflected energy of an object. As a result, the actual returned signal levels are extremely small and can be acquired only with extremely sensitive measurement instrumentation. The received signal will be very small due to the energy being transmitted and reflected ($1/R^4$ term) and the object reflection term σ , which is optimized for the smallest possible return. The level of the returned signal is also affected by the need to use large distances (due to object size) and ensure a planar wavefront.

As a result, instrumentation with very good sensitivity is essential. To achieve the best sensitivity, instruments such as the Keysight PNA-X network analyzer use mixer-based receivers. These provide better sensitivity than sampler-based converters.

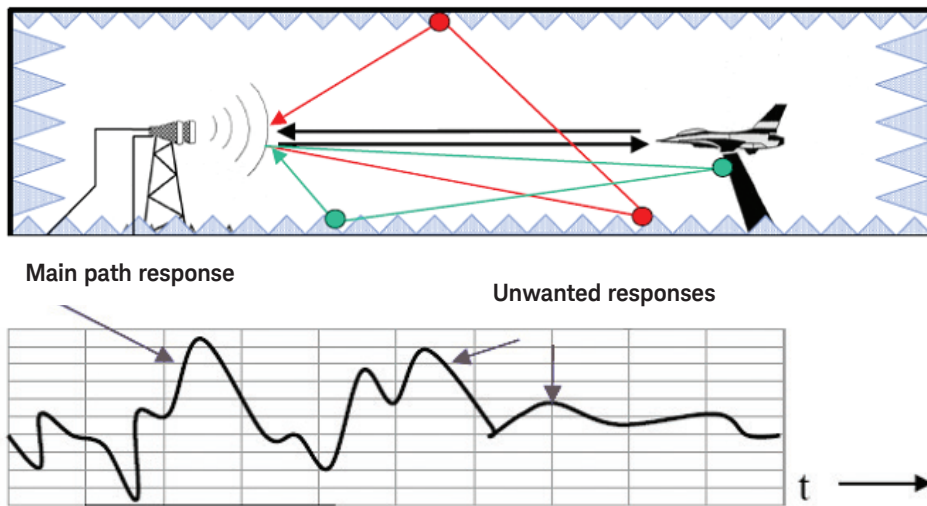
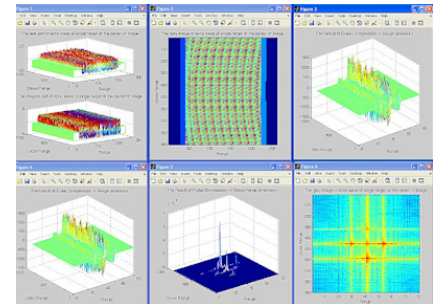

Figure 53. RCS signals are small and returns caused by the measurement chamber can interfere with the measurement results.

Because the signals are tiny, small reflections caused by elements in the range itself can contribute a significant amount of reflected energy. To solve this problem, advanced network analyzers such as the PNA/PNA-X provide a time-gating feature that can remove the unwanted signals. This is achieved by computing an inverse fast Fourier transform (IFFT) on the measured frequency data, mathematically removing the unwanted signals, and then computing an FFT to restore the frequency result. Figure 53 illustrates this concept.

An artifact of computing the IFFT on a finite sampling is that it will create repetitions of the fundamental signal in time (“aliases”). These artifacts or aliases can be worked around through a process of testing to create an alias-free measurement span. The width of this span will depend partly on the number of data points the analyzer is able to measure and process. A typical number of data points for a network analyzer may be 1601, which is suitable for an alias-free range required for many measurements. However, because more may be needed, the PNA/PNA-X network analyzer provides 20,001 points to ensure wide alias-free spans. More detail on the time gating process can be found in Keysight Application Note 1287-12, *Time-domain Analysis with a Network Analyzer*, publication number 5989-5723EN. [8]

W1905EP SystemVue radar model library



Explore tradeoffs in radar system architectures within an electronic system-level (ESL) design environment

- Utilize approximately 70 highly parameterized simulation blocks and 50 higher-level reference designs
- Create working radar system scenarios including radar processing blocks, environmental effects, and more, with support for the following technologies:
 - Pulsed-Doppler (PD) radar architectures
 - Ultra-wideband (UWB) radars, and wideband receivers
 - Phased-array and digital array radars (DAR)
 - Synthetic aperture radars (SAR) and beamforming for raster imaging and mapping
 - Stepped-frequency radars (SFR) for ground- and wall-penetrating designs
 - MIMO radars for increased range resolution and robustness
- Add targets, clutter, fading, noise, interferers and RF effects
- Model the probability of detection given an RCS value (σ)

Noise figure

As accounted for in the derivation of the radar range equation, the threshold of the radar receiver is based on four factors: noise figure (NF), KT (Boltzmann's constant * temperature), the noise bandwidth of the system, and the S/N ratio. KT is the familiar -204 dBW/Hz, effectively a constant with little opportunity for improvement. The system bandwidth is dictated by the radar design, and the S/N cannot be improved once the signal gets to the receiver. Thus, receiver noise figure becomes a term of great interest for receiver optimization.

When considering NF, it is helpful to review Friss's formula. First, to avoid confusion, noise factor (F) is a ratio of the S/N at the input versus S/N at the output of a device. Noise factor is therefore a unit-less ratio, whereas noise figure (NF) is $10 \log$ of the noise factor and is expressed in decibels.

Friss's formula describes how the noise factor of successive components in a system adds up to determine the total noise factor of the system.

$$F_{\text{Total}} = F_1 + \frac{F_2 - 1}{G_1} + \frac{F_3 - 1}{G_1 G_2} + \dots$$

Where F_x is the noise factor for each successive element.

What is telling about the formula is that the first component in the chain, usually an amplifier, typically has the greatest impact on the overall NF because the effects of the other elements are reduced by the gain of the previous element.

At first glance one might be inclined to believe that noise figure is an area in which great improvement in system performance can be achieved at little cost. Modern, low-noise amplifiers can deliver very low noise figures. Properly engineered into the receiver architecture, the system noise figure penalty can be minimal. Therefore, it would seem more economical to reduce receiver noise figure by 3 dB rather than to increase transmitter power by the same amount. However, the reality is not quite that simple. The receiver designer must also be concerned with providing adequate gain, phase stability, amplitude stability, dynamic range, fast recovery from overload and jamming, and reliability. In addition, protection must be provided against overload or saturation and burnout from nearby transmitters.

From these considerations, many radar receivers do not employ low-noise RF amplifiers in the receiver frontend, but simply use a mixer as the first receiver stage. Even so, NF is a critical metric that must be optimized within other given restraints.

Today, two main methods are used for measuring noise figure. These are the Y-factor or hot/cold source method and the direct noise or cold-source method. This section will discuss these two methods and the instruments used to make them.

Y-factor measurement technique

The Y-factor or hot/cold source technique is most prevalent. It relies on a noise source that is placed at the input of the DUT. The noise source generates excess noise compared to a room-temperature termination. When the noise source is turned off, it represents a cold-source termination (or the same termination as would be present with a passive termination at room temperature). When the noise source is turned on, it presents a hot termination. While not physically hot, the noise source's excess noise can be described by an equivalent temperature that would produce the same amount of noise from a hypothetical termination at that temperature. With these two termination states (hot and cold), two measurements of noise power are made at the output of the DUT. The ratio of these two powers is called the Y factor. Using the Y factor and the ENR (excess noise ratio) calibration data from the noise source, the overall noise factor of the system can be determined by the following equation:

$$F_{\text{sys}} = \frac{\text{ENR}}{Y - 1} \quad \text{Where ENR} = \frac{T_h - T_c}{T_o}$$

Note that this equation results in the noise factor of the system, which includes the measurement instruments. In cases where the gain of the DUT is high, the noise factor of the system may be used to approximate the noise factor of the DUT. However, this may not be the case. Removing the noise factor effects of the measurement instrumentation requires calibration. This is done by having the measurement system measure its own noise factor and gain and then calculating out its own contribution using Friss's equation. (More detail on the Y-factor method can be found in Keysight Application Note 57-1, *Fundamentals of RF and Microwave Noise Figure Measurement*, literature number 5952-8255E.) [14]

The Y-factor method is the method most likely used by dedicated noise-figure analyzers and by spectrum/signal analyzers with built-in noise-figure functions. Examples of instruments that use the Y-factor technique include the Keysight NFA Series noise figure analyzers and the Keysight PXA Series signal analyzer. These instruments simplify the measurement process by automating it and the associated measurement calculations. In the case of the Keysight SNS noise sources and the NFA Series noise figure analyzers, the process of entering ENR calibration data is done automatically by loading the values into the analyzer from an electrically erasable programmable read-only memory (EEPROM) within the noise source.

Direct-noise or cold-source measurement technique

The second method is called the cold-source or direct-noise technique. With this method, only one noise-power measurement is made at the output of the DUT; the input of the amplifier is terminated with a source impedance at room temperature. The cold-source technique requires an independent measurement of the DUT's gain. Consequently, this technique is well-suited for use with vector network analyzers (VNAs) because they can make very accurate error-corrected measurements of gain. It does, however, also require a network analyzer that can make noise as well as CW measurements. An example of a VNA capable of making noise-figure measurements is the Keysight PNA-X network analyzer.

Using a VNA to make noise-figure measurements has several advantages. One is the ability to make other important measurements during the same connection to the DUT. For example, the PNA-X is able to measure NF, gain, IMD, and S-and X-parameters. In addition, analyzers such as the PNA-X are able to utilize advanced error-correction techniques including the use of an ECal electronic calibration module as an impedance tuner to correct for imperfect system source match. This is especially useful in an automated test environments that use switch matrices. These advanced features, combined with the very good sensitivity of the PNA-X, provide the highest performing noise figure solution from Keysight.

Selecting the best noise-figure measurement solution

The best noise figure solution will depend on the measurement objectives, relative NF and gain of the DUT being measured, and the cost restraints.

A signal analyzer-based noise figure solution generally has the lowest incremental cost and provides the versatility to perform spectrum measurements such as transmit spectrum, IMD and spurious. However, a signal analyzer will generally have greater measurement uncertainty than a dedicated NF analyzer. This is due in part to the higher noise figure of most signal analyzers. For high gain devices, however, the noise figure of the measuring analyzer will have minimal effect on measurement uncertainty. As a result, signal analyzer-based solutions may be the best solution for measuring high-gain devices.

A dedicated noise figure analyzer such as the Keysight NFA is designed to have low noise figure and low measurement uncertainty. The NFA analyzer may provide the best solution when a high level of measurement accuracy is required without the extra performance and cost of a noise figure-capable network analyzer. Ultimately, the right solution may depend on which solution meets your specific performance requirements. More information on optimizing and determining the accuracy of Y-factor based solutions can be found in Keysight Application Note 57-2, *Noise Figure Measurement Accuracy: The Y-Factor Method*, literature number 5952-3706E. [15]

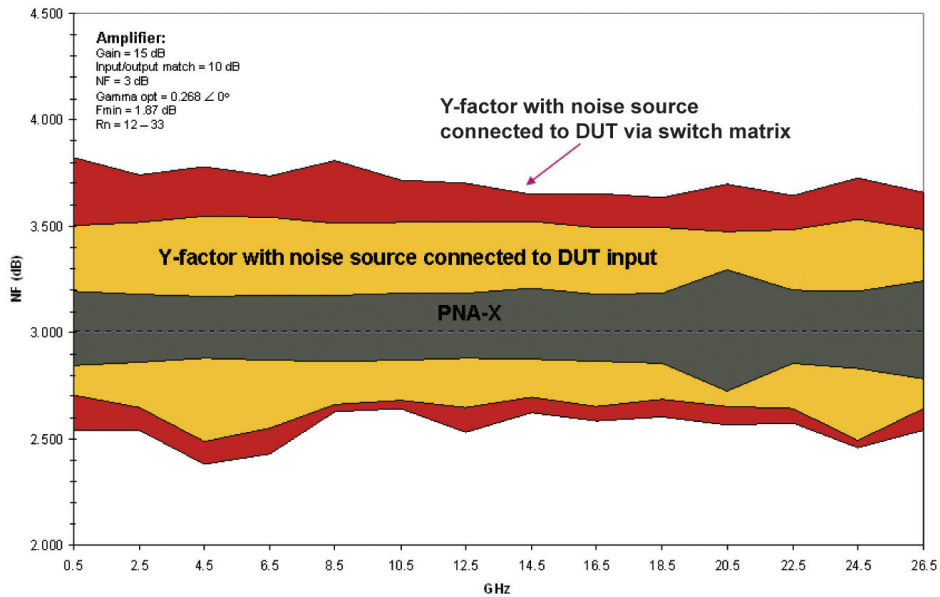

Figure 54. PNA-X-based noise figure solution provides the best measurement uncertainty due to its high sensitivity and ability to use vector error corrections to subtract errors due to effects such as impedance mismatch.

The cold-source-based PNA-X network analyzer noise figure solution offers the highest level of performance for noise figure from Keysight for reasons previously stated. Figure 54 shows a typical comparison in accuracy using the traditional Y-factor method with a traditional noise figure solution compared to the cold-source method using a PNA-X with source correction and vector calibrations. Results are shown with and without a switch included in the test system. An additional benefit of the PNA-X solution is that it also offers measurement capability such as S-parameters, X-parameters and IMD with a single connection to the DUT.

Time sidelobe level

In a radar system, the use of modulation on a pulse for compression provides enhanced spatial resolution as well as extended range for a given output power level. Unfortunately, traditional RF pulse measurements become less effective predictors of performance in radars that use pulse compression. For example, the width of an uncompressed pulse is directly related to spatial resolution. Compare this to a system that uses linear frequency-modulated (LFM) chirp pulses: resolution depends on pulse width, chirp bandwidth and chirp linearity.

A technique called the time sidelobe level (SLL) measurement is a viable way to predict performance in terms of spatial resolution, dynamic range, and more. The SLL method distills a wide range of potential signal impairments down to a simple metric that can be used to determine if radar performance will fit the intended application.

Understanding time sidelobes

Time sidelobes are the result of the return-pulse energy residing outside the pulse bandwidth. In the time domain, this is indicated by a spreading in range (time) of the return pulse.

When pulse-compression techniques are used, any anomaly within the transmit or receive chain can contribute to the time SLL. If the transmitter produces a less-than-ideal pulse, time sidelobes will appear when the return signal is passed through the correlation filter and compressed. If any RF or IF mismatches occur in the receive path, or if the correlation filter is not properly optimized, then the time sidelobe level will increase.

In modern systems, the correlation filter is most often implemented using DSP rather than an analog filter. As a result, the compressed-pulse waveform is mathematically deterministic and repeatable—and this means it can be easily optimized through simulation.

Applying the time sidelobe method

The detector in a radar receiver correlates the transmitted signal with echoes and noise received over time. When the received signal matches the sent signal, a correlation peak occurs and target detection is marked at that time.

An ideal correlation peak would be infinitely narrow, have a value of one, and be surrounded by noise-like sidelobe levels. At the other extreme, the correlation between a pure signal and pure noise is zero.

System impairments ranging from imperfectly generated compressed pulses to internal reflections from filters can cause correlation sidelobe levels well above the noise floor (Figure 55). It is difficult to judge the effect of such impairments on a compressed pulse; however, the SLL technique provides quantitative measurements of transmitted pulse shapes and received signals.

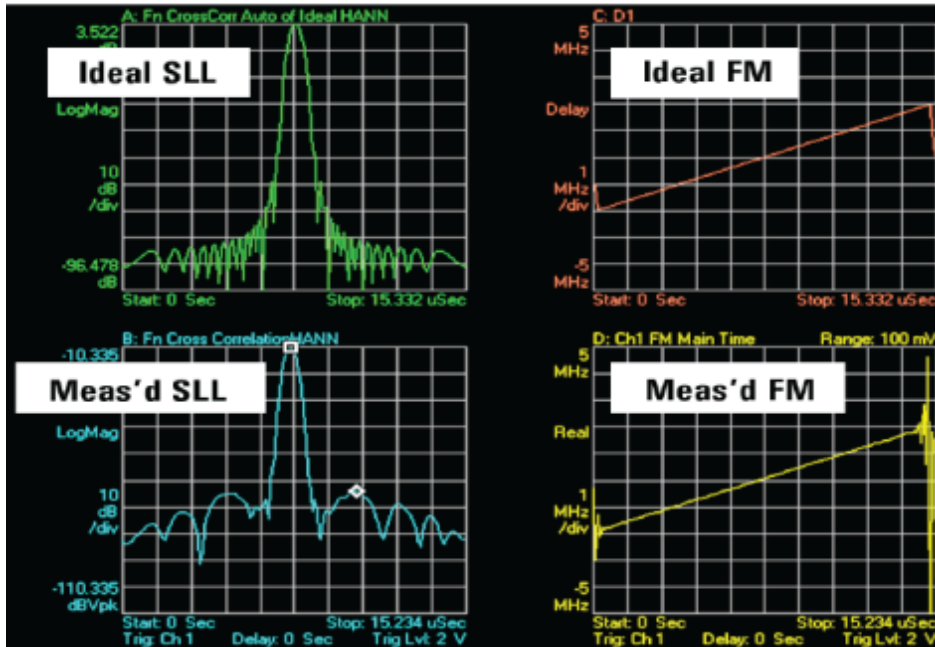

Figure 55. Example SLL measurements made with the 89600 VSA software

An accurate measurement of SLL requires a filter that is perfectly correlated to the desired pulse shape. The first step is to build an ideal waveform that represents the desired compressed pulse: the essential parameters are bandwidth, pulse width and chirp or modulation characteristics. Modeling can be performed with software such as SystemVue or Signal Studio for pulse building from Keysight or MATLAB from The MathWorks. The mathematically generated, ideal representation of the compressed pulse (i.e., repeatable with no impairments added) can be stored in memory and recalled later to correlate measured waveforms and enable calculations of SLL.

The FM chirp pulse waveform for the SLL measurement and calculation should be designed to imitate the operational waveform of the radar system. For systems that feature multiple operating modes, multiple waveforms should be used and multiple SLL measurements performed. The pulse-generation platform should provide repeatability when creating and recreating the pulses for the measurement stimulus and for the relative-comparison measurement.

When measuring pulse waveforms that will be correlated for SLL calculations, instrument calibration and waveform correction are other important factors. The reason: The wide-band nature of most compressed pulses gives rise to potential inaccuracies in both phase and amplitude versus frequency within the measurement instrument. To prevent these inaccuracies from affecting SLL measurements, it is essential to use a measuring receiver with built-in equalization and signal-generation software or hardware with pre-distortion or real-time correction capabilities.

N6171A MATLAB software

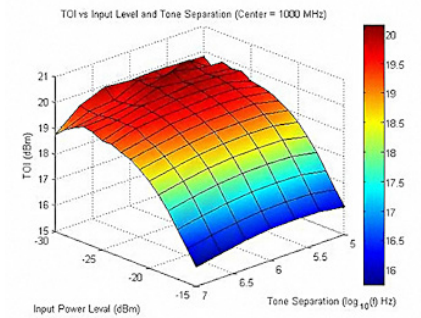

This well-respected software environment and programming language is available directly from Keysight as an option to most signal generators, signal analyzers and spectrum analyzers. Three configurations are available: basic, standard and advanced.

MATLAB extends the capabilities of compatible instruments to help you make custom measurements, analyze data, visualize results and create arbitrary waveforms. It also provides interactive tools and command-line functions for data-analysis tasks such as signal processing, signal modulation, digital filtering and curve fitting.

Weighting the output signal

Amplitude weighting of the output signal is generally used to reduce the time sidelobes to acceptable levels. One common side effect: signal weighting causes a decrease in the signal-to-noise ratio (SNR).

A variety of popular windowing functions can be used to provide the necessary weighting. Table 1 shows the suppression levels and SNR changes associated with five commonly used windows. Figure 56 provides a graphical representation of the Hamming window function and its associated frequency response.

Table 1. Five popular windowing functions and their associated effects

Weighting function	Peak sidelobe level (dB)	SNR loss (dB)
Uniform	-13.2	0
Hamming	-42.8	1.34
Hann	-32.0	1.40
Blackman	-58.0	2.37
Blackman-Harris (three-term)	-67.0	2.33

Figure 56. Shape of the Hamming windowing function (left) and its associated frequency response (right)

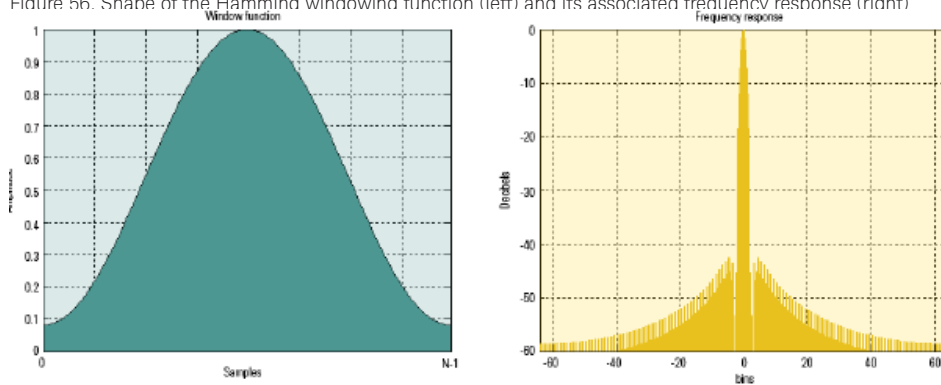

Making time sidelobe measurements

The measurement process starts with detailed knowledge of the ideal compressed pulse, as described above. The next requirement is a suitable wideband instrument—signal analyzer, oscilloscope or logic analyzer—equipped with VSA software. Example instruments include Keysight PXA or MXA signal analyzers and Infiniium 90000 X-Series or Q-Series oscilloscopes. These all support the 89600 VSA software, which is capable of implementing the mathematics needed to make and display the time sidelobe measurement.

The instrument is used to acquire and digitize the measured waveform. The VSA software can be configured to use the time cross-correlation identity, an approach that is much less cumbersome than performing a time-domain cross correlation between data files. Using the identity makes it possible to take the measured frequency data and multiply it by the ideal pulse created earlier. Before making the measurement, the ideal pulse must be imported into the VSA software and transformed into the VSA's file format. One important note: To ensure a successful SLL measurement, the imported file and the measured data must use the same sample rate.

Once these preparations are complete, the measurement can be performed. Within the VSA software, the measured frequency data (with real and imaginary values) is multiplied by the ideal pulse. This result is processed with the IFFT function to produce the time cross-correlation needed for the SLL measurement.

Applying the results

Because the time from the main correlation lobe to the minimum discernible sidelobe is directly related to the minimum spatial resolution, SLL offers an effective go/no-go assessment of a radar system's field performance. SLL also provides assurance that no other internally generated sidelobe will affect the overall threshold performance of the radar.

The correlation function is also directly tied to the probability of target detection. From this, a sufficiently low SLL value ensures the radar hardware under test will have sufficient dynamic range to detect weak target return signals.

At the component level, time sidelobe testing can help identify problems with analog microwave devices. Rather than sifting through a vast number of measurements, time sidelobe levels can be evaluated for impairments at any point within the system—and this makes it possible to rapidly determine if the radar pulses can deliver the required level of performance. In addition, the ability to assess pulse quality virtually anywhere between transmitter and receiver detector makes SLL a valuable diagnostic tool. For example, one quick SLL measurement can pinpoint either the transmitter or receiver as the source of a problem. Subsequent measurements can quickly isolate signal impairments that may cause radar performance to fall short of system requirements.

Phase noise, AM noise, and spurs

Phase noise, AM noise and spurs can have significant performance implications for radar. Phase and AM noise in the receiver decrease the S/N ratio. Noise on the transmit signal affects radar returns with noise that can hide low-level Doppler target signals in the presence of clutter. Spurs created by unwanted discrete PM or AM oscillations can result in false targets.

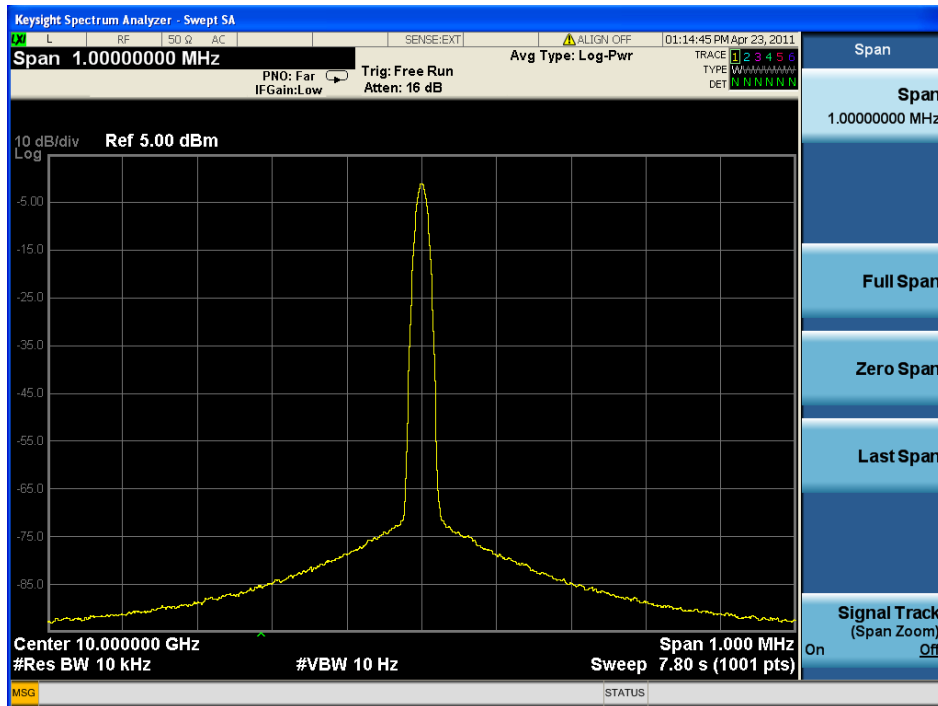

Figure 57. Phase noise results in sidebands that spread power into adjacent frequencies reducing the signal-to-noise ratio

Phase noise is the result of random fluctuations in phase on a signal caused by time-domain instabilities. In the time domain, this effect is called jitter. In the frequency domain, this instability manifests itself as sidebands that spread power to adjacent frequencies, as shown in Figure 57. If the phase variations are random or random-like, the sidebands will slope downward from the signal. If, however, the phase variations of the signal are due to specific non-random oscillations the result will be discrete spectral components or spurs. AM noise also spreads power into adjacent frequencies. Phase noise is more dominant at closer frequency offsets while AM noise may become more dominant at wide offsets.

In radar, good phase noise is critical for stable local oscillators (STALOs) and coherent oscillators (COHOs) because these signals are at the heart of the radar. Any phase impairments on these signals will be multiplied as they are transferred up to the higher frequency transmit and receive signals, effectively reducing the S/N ratio.

Phase and AM noise effects may be particularly harmful for moving target indicator (MTI) radars. These radars work on the principle that the return from a moving target will be shifted in frequency as a result of Doppler effects. Typically, these target returns are small when compared to the clutter that is returned from stationary objects such as the ground or a mountainside. Because the clutter and the target returns are at different frequencies, the clutter is filtered away and the target's returns examined. However, the clutter-canceling filters will not be able to remove the noise on the clutter. Good noise performance on the transmit signal is therefore important for the operation of the radar.

Different solutions are available for measuring phase noise. The appropriate solution will depend on cost and performance constraints. Although phase noise measurements on CW signals within the radar, including the STALOs and COHOs, are critical, it may also be necessary to measure the phase noise of pulsed signals or understand the phase noise contributed by system components such as the power amplifier (residual or additive phase noise). This is especially true for Doppler radars in which it is critical to understand the phase noise through the transmit path under normal operating conditions.

Instruments that may be used to measure phase noise include signal analyzers, signal source analyzers, or dedicated phase noise test systems.

A signal analyzer-based phase noise measurement solution typically offers the lowest-cost option. A dedicated signal source analyzer such as the Keysight SSA signal source analyzer provides high performance and efficiency for measuring oscillators and phase-locked loops (PLLs). A phase noise test system is more complex but offers the greatest flexibility and performance. A phase noise test system may be the only available solution capable of making pulsed and residual phase noise measurements.

Making a direct spectrum measurement of phase noise

Phase noise measurements made with a signal analyzer require direct analysis of the spectrum and an examination of the levels of the phase-noise sidebands. This process can be done manually with any signal analyzer simply by using marker functions and measuring the noise level at the desired offset frequency. Phase noise is typically measured in dBc/1 Hz and therefore should be normalized to 1 Hz based on the RBW setting. In addition, a noise-correction term may also be needed depending on the detector and display mode. (For more information see Keysight Application Note 1303, *Spectrum Analyzer Measurements and Noise*, literature number 5966-4008E.) [5] To simplify, most signal analyzers include an automated noise-marker function. When measuring the noise with a spectrum analyzer, phase and AM noise are actually included in the result; however, because phase noise is usually dominant, the measurement is often referred to as just phase noise.

Many signal analyzers also include automated single-sideband (SSB) phase noise measurement functions. Figure 58 shows an example of a phase noise measurement taken using an Keysight PXA spectrum analyzer with the optional N9068A phase noise measurement application. The measurement application works for CW signals. The range of offsets and levels of the phase noise that can be measured by a signal analyzer will depend on the available RBW settings and the phase noise of the instrument itself. In the case of the PXA, it is able to measure offsets as close as 100 Hz. Its typical performance at a 10 kHz offset is -129 dBc/1 GHz.

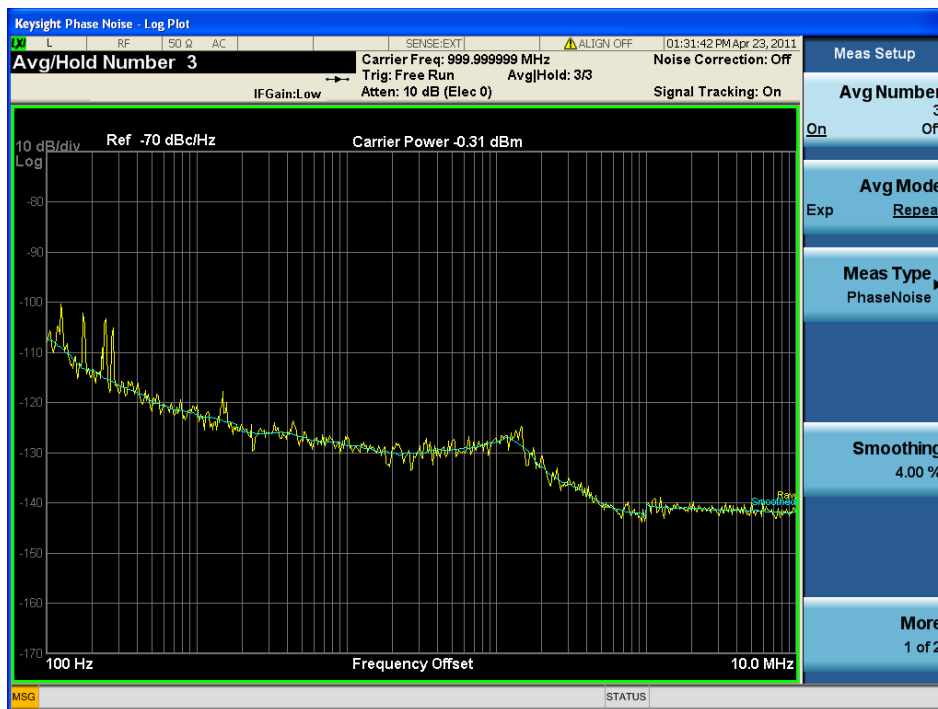

Figure 58. With the PXA spectrum analyzer phase noise measurement application, results are displayed as a function of offset frequency from the carrier

Measuring phase noise using a phase detector

To achieve the best sensitivity and accuracy, most dedicated phase noise and signal-source analyzers are based on a phase detector, as shown in Figure 59. Most phase detectors are balanced mixers that require both RF and reference signals. When the RF and reference signals are in quadrature with respect to each other and applied to the balance mixer, the IF output provides a measure of the instantaneous phase difference between the two signals. In most implementations, the quadrature phase relationship is maintained using a narrowband PLL. The instantaneous phase difference is represented by an instantaneous voltage change around 0 volts. Using the double-balance mixer, in quadrature, suppresses amplitude noise while phase noise is being measured. The noise-voltage (IF output) is then amplified and spectrally processed to determine the noise and spurious signals as a function of offset frequency. Phase noise measurement systems also typically include a separate AM detector to measure amplitude noise and amplitude spurious signals as a function of offset frequency. The AM detector may be diode- or mixer-based.

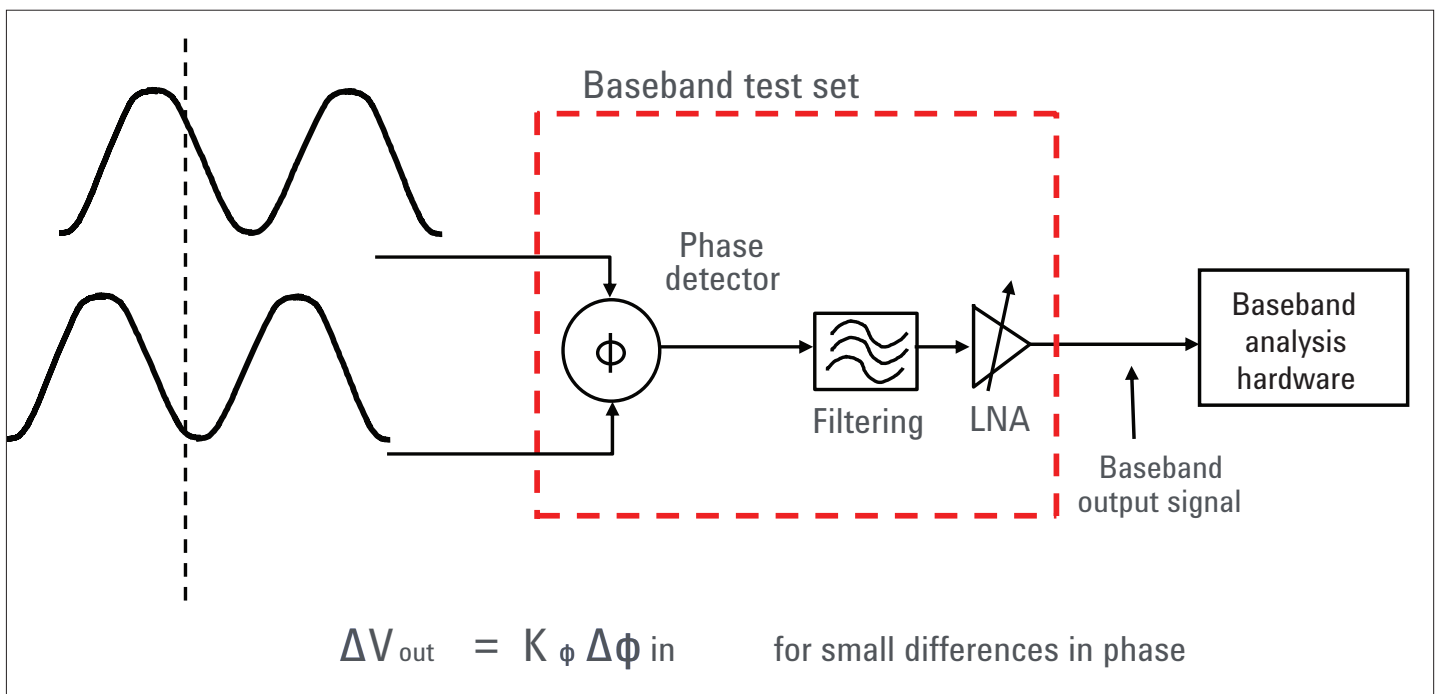

Figure 59. A basic block diagram of phase detector-based phase noise measurement. The measurement compares the test signal to a phase-locked reference signal with a phase detector. Variations in phase due to phase noise result in a voltage output that is then processed to determine the phase noise result.

The measurement sensitivity is limited by the phase noise of the reference oscillator or any microwave downconverter used in the measurement. New phase noise analyzers use advanced cross-correlation techniques to improve the measurement performance beyond that of the reference oscillator and downconverter. This is especially useful in measuring voltage-controlled oscillators (VCOs), which tend to have very low, far-from-carrier phase noise characteristics. For measurement systems that do not use cross-correlation techniques, a mathematical correlation can be done against three sources to extract actual noise performance of each source. (Keysight Technologies, *Users Guide Keysight Technologies E5500A/B Phase Noise Measurement System*, part number E5500-90004, 2000).

Measuring phase noise using a signal-source analyzer

The Keysight E5052A signal source analyzer (SSA) is one such instrument that employs cross-correlation techniques to dramatically improve measurement performance. For convenience, the analyzer includes its own reference oscillators. The SSA is designed to efficiently and rapidly process cross correlations to obtain the maximum performance and efficiency. As a result, the SSA offers a very high level of performance while keeping costs low.

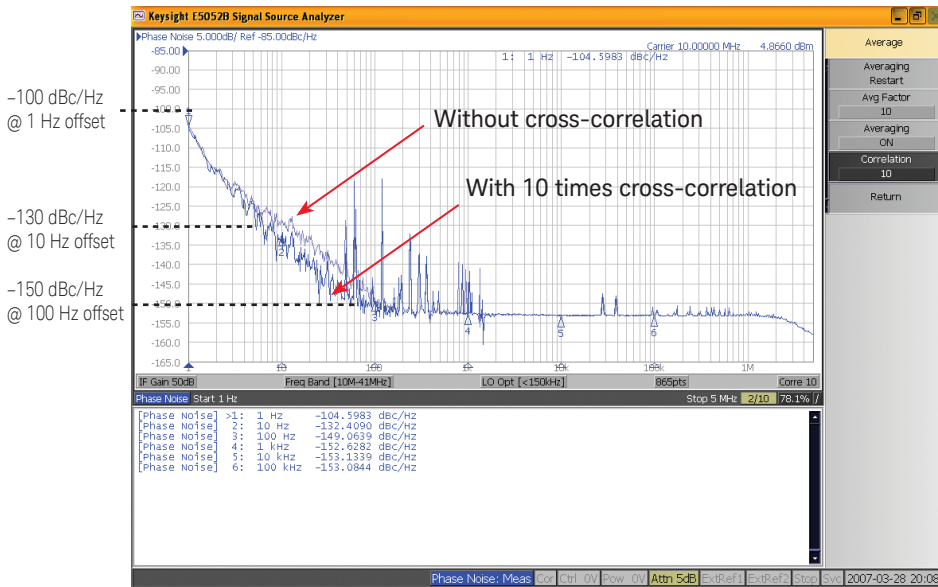
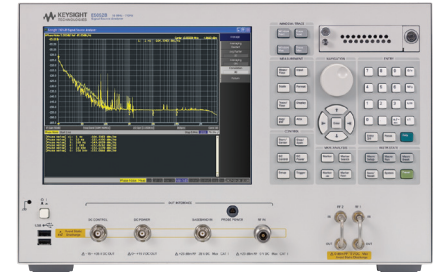

Figure 60. This phase noise measurement uses Keysight's signal source analyzer (SSA). The phase noise measurement is improved using a cross-correlation technique.

Figure 60 shows an example phase noise measurement using the SSA with different levels of cross correlation. The time tradeoff on the SSA analyzer for an improvement in 5 dB computing 10 correlations is approximately a 10 times longer measurement time.

E5052B signal source analyzer



Characterize the performance – phase noise, transients for high frequency signal sources up to 110 GHz

- World's fastest measurement throughput in the characterization of VCOs and other high-frequency sources
- Advanced cross-correlation technique for maximum performance
- Simultaneous transient measurements for frequency, phase, & power over time
- Real-time spectrum monitoring

In addition to phase noise, the DSP-based SSA also provides many other functions that can be useful for the testing of radar oscillators. Because it samples the signal and is DSP-based, the analyzer includes the ability to analyze amplitude, frequency, and phase as a function of time. It can also perform transient analysis by triggering on frequency anomalies. The SSA provides two receiver channels: a wideband channel to monitor frequency change and a narrowband channel to capture the frequency-versus-time profile very precisely. The signal can be measured simultaneously on both channels while either the wideband or narrowband channel monitors the signal for frequency changes. These frequency changes can then trigger and capture the transient event. An example is found in Figure 61, which shows the capture and analysis of a phase hit.

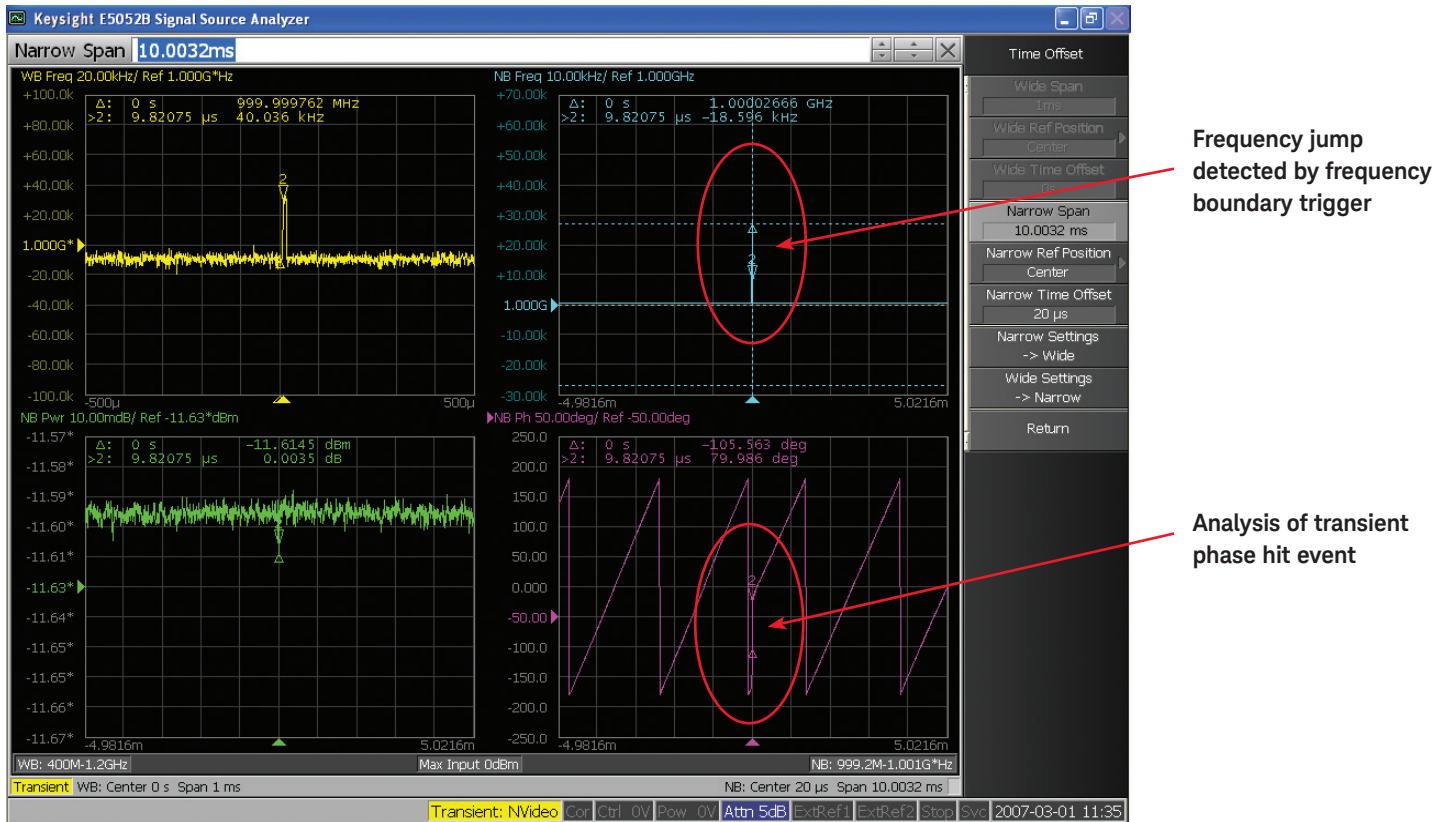

Figure 61. The SSA includes time-domain analysis and advanced trigger functions useful for examining transient events. In this screen, the analyzer is able to use its frequency-boundary trigger to capture and analyze a phase hit.

Measuring phase noise with a dedicated test system

A solution such as the Keysight E5500 phase noise measurement system offers the most flexibility and performance. Its capabilities are especially useful for radar because it can perform pulsed absolute and residual (or additive) phase noise measurements. It is also able to measure over a wide range of frequency offsets from 0.01 Hz to 100 MHz. As with the SSA, the E5500 is phase-detector-based but requires a separate reference oscillator.

The main components of an E5500 system include a low-noise downconversion module, an external reference source, a phase noise test set (detector, PLL), a digitizer-based FFT analyzer (and/or a swept spectrum analyzer,) and PC software. Based on its modular system design, different hardware components can be used to satisfy a variety of measurement requirements. The E5500 works well in ATE applications because it is fully programmable, and because it can share common components such as the reference source and spectrum analyzer for other measurement uses. E5500 options include absolute or residual measurements, CW or pulsed phase noise and spurious measurements, and AM noise measurements.

Figure 62.

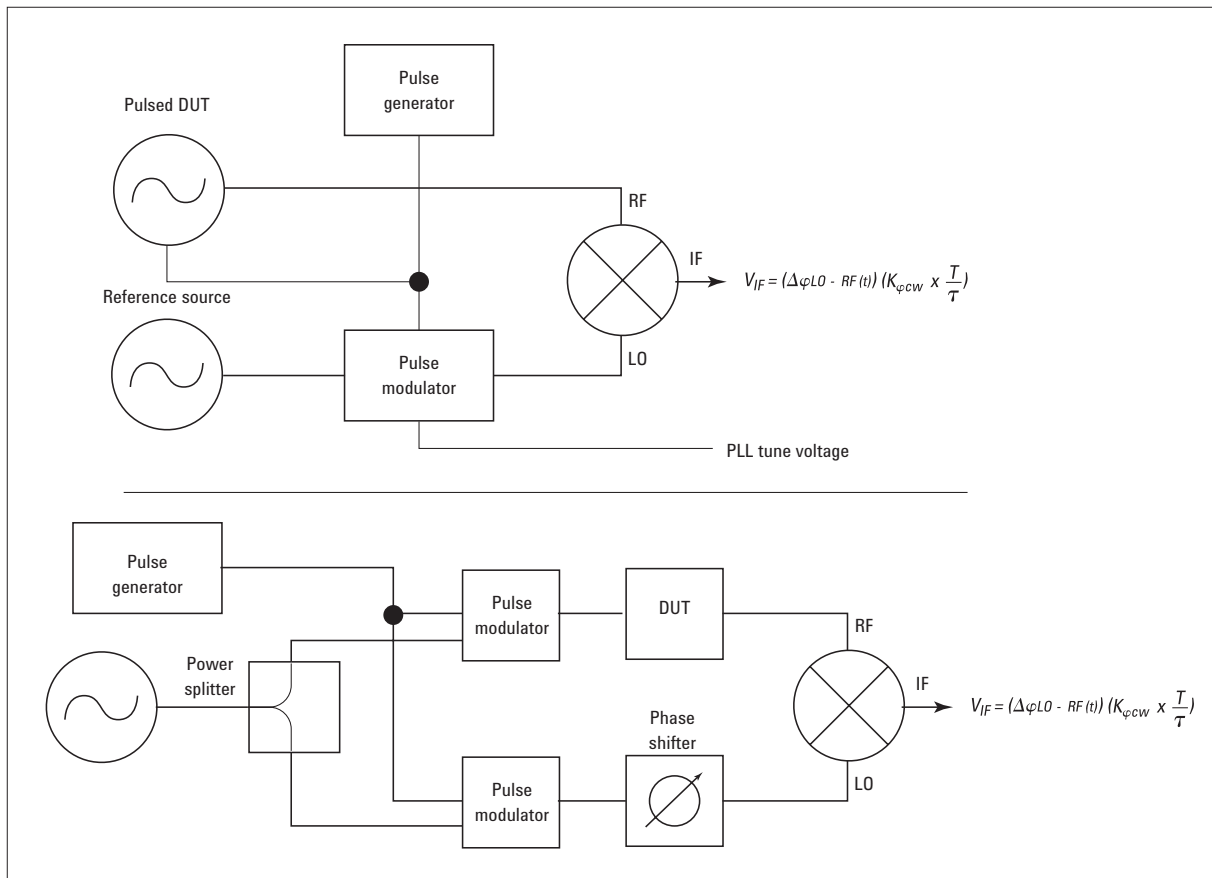

Pulsed and residual phase noise measurements are especially helpful for pulsed radar systems. These measurements are available with the E5500 system but not with a spectrum analyzer-based system or SSA. Figure 62 shows a basic block diagram of the configuration used for pulsed absolute and residual phase noise measurements. Detail on how phase noise measurements are performed using the E5500 system can be found in Keysight Application Note 1309, *Pulsed Carrier Phase Noise Measurements*, literature number 5968-2081E. [17]

Figure 62.
Test configuration for making absolute and residual pulsed phase noise measurements using the Keysight E5500 phase noise test system

5.0 Summary

Since the days of Nikola Tesla and other pioneers, radar has become ubiquitous and the breadth of its application is still growing. At the same time, radar technology has become more sophisticated as signal processing is commonly used to enhance the returned signal and to extract information, such as target images during post-processing. However, no matter how sophisticated the signal processing becomes, the performance of every radar system is directly determined by the quality of the underlying transmitters and receivers.

Understanding radar measurements and how instrumentation responds to radar signals is crucial to designing high-performance and cost-effective radar solutions. This application note has sought to provide an explanation of common radar measurements and highlight the measurement solutions available today. Critical radar measurements include power, spectrum, pulse characteristics, antenna gain, target cross section, component gains and losses, noise figure, and phase noise—all of which can be shown, through the radar range equation, to directly influence the performance of the radar. These measurements should always be made using quality test equipment designed to deal with the unique and demanding characteristics of radar systems and signals.

Related information

- Application note: *Radar, EW & ELINT Testing: Identifying Common Test Challenges*, publication 5990-7036EN
- Application note: *Designing, Verifying and Testing Stepped-Frequency Radar Systems for Commercial and Aero/Defense Applications*, publication 5991-1350EN
- Application note: *Solutions for Wideband Radar and SATCOM Measurements*, publication 5990-63653EN
- Application note: *Microwave and Millimeter Signal Measurements: Tools and Best Practices*, publication 5990-8892EN
- Application note: *Using Keysight SystemVue to Create Realistic Scenarios for Radar and EW Applications*, publication 5990-7533EN
- Application note: *Making Wideband Measurements*, publication 5990-9108EN
- Application note: *Reducing Phase Noise at RF and Microwave Frequencies*, publication 5990-7529EN
- Application note: *Creating a Radar Threat Simulator and Receive Calibrator with Precise Angle of Arrival*, publication 5990-8430EN
- *2013 Aerospace Defense Symposium - DVD*, publication 5991-1514EN *

* While supplies last

References

- [1] Skolnik, M.I., *Introduction to Radar Systems*. 3rd ed. New York, NY: McGraw-Hill, 2002
- [2] Keysight Technologies, *2007 A/D symposium Presentation, Radar System Performance Measures*, Keysight symposium CD, Literature Number 5989-6075EN, 2007
- [3] Keysight Technologies, *Application Note 150-2, Keysight Spectrum Analyzer Series, Spectrum Analysis ... Pulsed RF*, Literature Number 5952-1039, 2009
- [4] Keysight Technologies, *2004 A/D Symposium Presentation, Fundamentals of Pulse RF Analysis Using a Spectrum Analyzer*, Keysight symposium CD Literature Number 5989-6075EN, 2004
- [5] Keysight Technologies, *Application Note 1303, Spectrum Analyzer Measurements and Noise*, Literature Number 5966-4008E, 2009
- [6] Keysight Technologies, *Application Note 150-15, Vector Signal Analysis Basics*, Literature Number 5989-1121EN, 2004
- [7] Keysight Technologies, *Application Note 1408-12, PNA Microwave Network Analyzers; Accurate Pulsed Measurements*, Literature Number 5989-4839EN, 2007
- [8] Keysight Technologies, *Application Note 1287-12, Time-domain Analysis with a Network Analyzer*, Literature Number 5989-5723EN
- [9] Keysight Technologies, White Paper, *Keysight's New PNA Receiver Reduces Antenna/RCS Measurement Test Times*, Literature Number 5989-1949EN, 2004
- [10] Keysight Technologies, *2004 A/D Symposium Presentation, Introduction to Antenna Measurements and Test Configurations*, Keysight symposium CD Literature Number 5989-6075EN, 2004
- [11] Orbit/FR, *Antenna Measurement Theory, Introduction to Antenna Measurement*, www.orbitfr.com
- [12] Keysight Technologies, Selection Guide, *Keysight Antenna Test*, Literature Number 5968-6759E, 2009
- [13] Keysight Technologies, *Application Note 1439, Measuring Noise Figure with a Spectrum Analyzer*, Literature Number 5988-8571EN, 2003
- [14] Keysight Technologies, *Application Note 57-1, Fundamentals of RF and Microwave Noise Figure Measurements*, Literature Number 5952-8255E, 2010
- [15] Keysight Technologies, *Application Note 57-2, Noise Figure Measurement Accuracy – The Y-Factor Method*, Literature Number 5952-3706E, 2010
- [16] Keysight Technologies, Product Note, *Pulsed Carrier Phase Noise Measurements Using Keysight E5500 Series Solutions*, Literature Number 5968-5662E, 2000
- [17] Keysight Technologies, Application Note, *Pulsed Carrier Phase Noise Measurements*, Literature Number 5968-2081E, 2006

myKeysight

myKeysight

www.keysight.com/find/myKeysight

A personalized view into the information most relevant to you.

www.keysight.com/find/ad



Three-Year Warranty

www.keysight.com/find/ThreeYearWarranty

Keysight's combination of product reliability and three-year warranty coverage is another way we help you achieve your business goals: increased confidence in uptime, reduced cost of ownership and greater convenience.

Keysight Solution Partners

www.keysight.com/find/solutionpartners

Get the best of both worlds: Keysight's measurement expertise and product breadth, combined with solution partner convenience.

For more information on Keysight Technologies' products, applications or services, please contact your local Keysight office. The complete list is available at:

www.keysight.com/find/contactus

Americas

Canada	(877) 894 4414
Brazil	(11) 4197 3600
Mexico	01800 5064 800
United States	(800) 829 4444

Asia Pacific

Australia	1 800 629 485
China	800 810 0189
Hong Kong	800 938 693
India	1 800 112 929
Japan	0120 (421) 345
Korea	080 769 0800
Malaysia	1 800 888 848
Singapore	1 800 375 8100
Taiwan	0800 047 866
Other AP Countries	(65) 375 8100

Europe & Middle East

Belgium	32 (0) 2 404 93 40
Denmark	45 45 80 12 15
Finland	358 (0) 10 855 2100
France	0825 010 700* *0.125 €/minute
Germany	49 (0) 7031 464 6333
Ireland	1890 924 204
Israel	972-3-9288-504/544
Italy	39 02 92 60 8484
Netherlands	31 (0) 20 547 2111
Spain	34 (91) 631 3300
Sweden	0200-88 22 55
United Kingdom	44 (0) 118 927 6201

For other unlisted countries:
www.keysight.com/find/contactus
(BP-01-15-14)

This information is subject to change without notice.

© Keysight Technologies, 2014
Published in USA, August 22, 2014
5989-7575EN

www.keysight.com